

Project: \_\_\_\_\_

Contact: \_\_\_\_\_

Fill in the shaded boxes using the information listed below

Order Code: **R-0015** -  X  -  -  -  -  -  -

Model      (A) DIAMETER      (B) HEIGHT      (D) FINISH 1      (E) FINISH 2      (F) OUTPUT      (G) LAMPING      (H) OPTION CODE

EXAMPLE ORDER CODE

R-0015 - 42 X 36 - 058 - 001 - H - 35 - EM



24" diameter X 34" Height - Cable Suspension - Frosted Polymer Side - Brushed Brass structure - 2700K

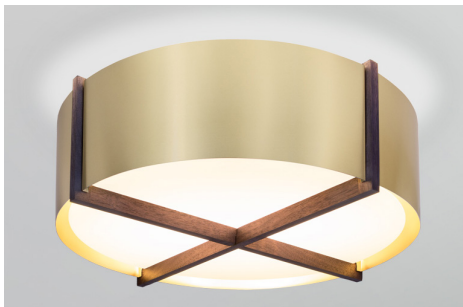

18" diameter X 6" Height - Brushed Brass side walls- Walnut structure - 2700K

**(A) DIAMETER**

Specify the Diameter in inches, even number 16 - 50

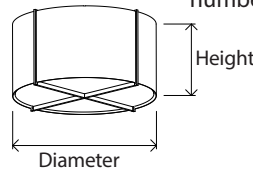

Specify the Height in inches, even number 6 - 48

Blacked out squares indicate size combinations not offered.

		DIAMETER in inches																		
		16	18	20	22	24	26	28	30	32	34	36	38	40	42	44	46	48	50	
HEIGHT in inches	6																			
	8																			
	10																			
	12																			
	14																			
	16																			
	18																			
	20																			
	22																			
	24																			
	26																			
	28																			
30																				
32																				
34																				
36																				
38																				
40																				
42																				
44																				
46																				
48																				

**(B) HEIGHT**

**(D) FINISH 1 - SIDE PANELS**

Translucent side panels  
**051** Frosted polymer

Opaque side panels  
**085** Matte Black

**012** Brushed Aluminum

**047** Brushed Brass

**096** Distressed Brass

**046** Brushed Rose Gold

**054** Gloss White

See page 3 for color swatches.

**(E) FINISH 2 - STRUCTURE**

Wood Structure

**001** Walnut

**002** Dark Stained Walnut

**095** White Washed Oak

Metal Structure

**006** Brushed Aluminum

**071** Brushed Brass

**114** Semigloss Black

**115** Semigloss White

See page 3 for color swatches.

**(F) OUTPUT**

<b>N</b>	Normal Output
<b>H</b>	High Output

See page 2 for output based on size of fixture and dimming information.

**(G) LAMPING CCT**

<b>27</b>	2700K LED
<b>30</b>	3000K LED
<b>35</b>	3500K LED
<b>40</b>	4000K LED

CRI 90+  
R9 values 85+

**(H) OPTION CODE**

**EM** Emergency Backup option. See page 2 for emergency backup details.



Lumen Output based on Diameter and Height combination

Relative shape and scale

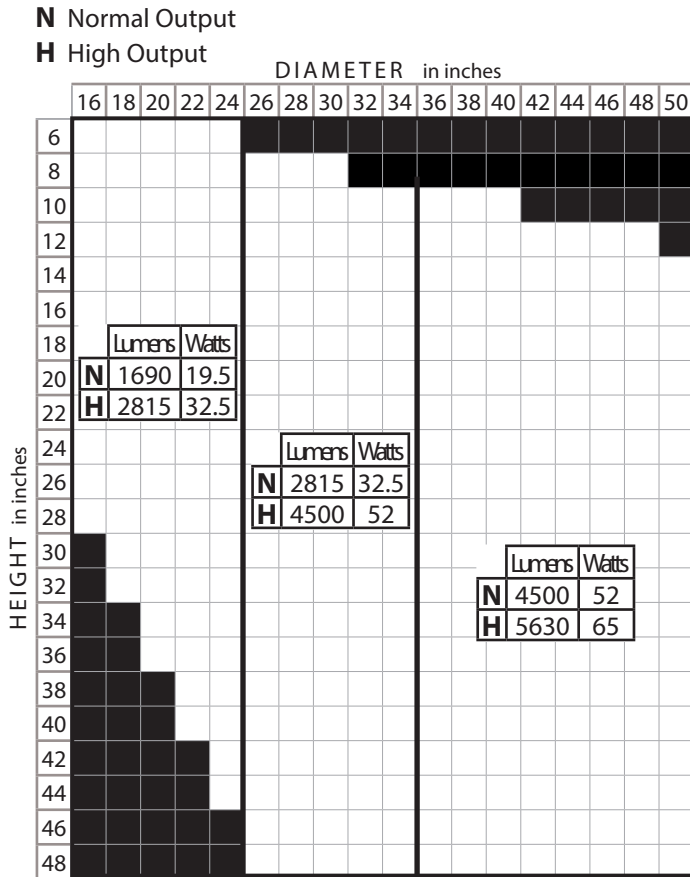

Source Lumens listed.

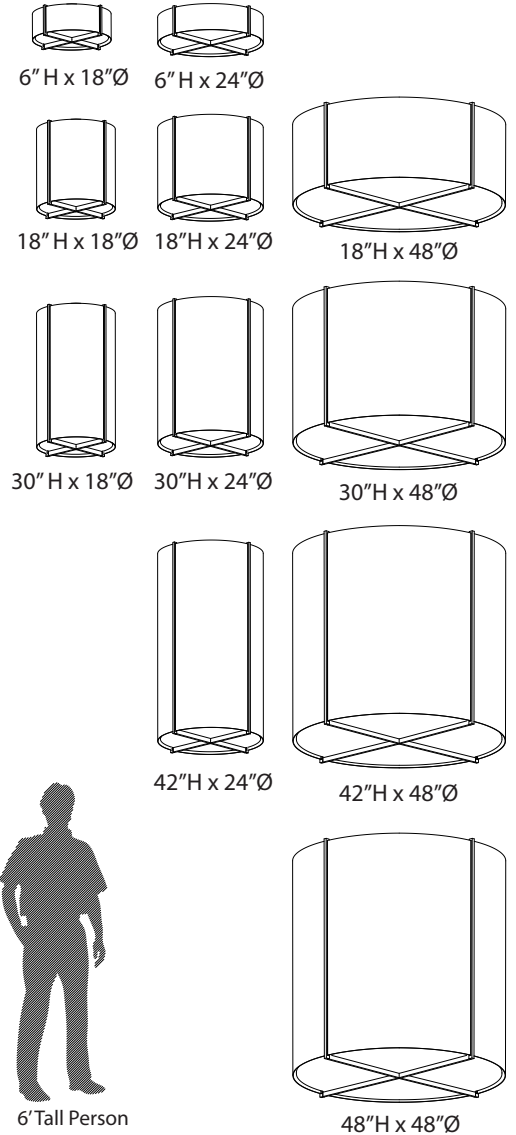

Dimming Performance

120 V AC input:  
0-10 V - 1% dimming  
TRIAC, ELV - 10% dimming (may achieve as low as 1% depending on dimmer)

240 & 277 V AC input:  
0-10 V - 1% dimming

Fixture Elevation

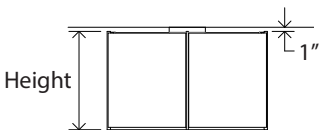







Emergency Backup

Emergency LED driver provided:  
100-277VAC input  
750 Lumens  
90 minutes of battery life  
Includes mounted test switch

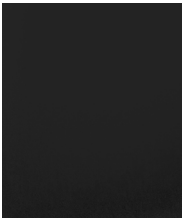
Detail - Brass Structure - Polymer Side



**Finish 1 - SIDE PANELS**

Translucent		Opaque				
						
051 Frosted Polymer CM - 051	085 Matte Black CM - 085	012 Brushed Aluminum CM - 012	047 Brushed Brass CM - 047	096 Distressed Brass CM - 096	046 Brushed Rose Gold CM - 046	054 Gloss White CM - 054

**Finish 2 - STRUCTURE**

Wood			Metal			
						
001 Walnut CM - 001	002 Dark Stained Walnut CM - 002	095 White Washed Oak CM - 095	006 Brushed Aluminum CM - 006	071 Brushed Brass CM - 071	114 Semigloss Black CM - 114	115 Semigloss White CM - 115