

Project: \_\_\_\_\_

Contact: \_\_\_\_\_

Fill in the shaded boxes using the information listed below

Order Code: **R-0010** - \_\_\_\_\_ X \_\_\_\_\_ - \_\_\_\_\_ - \_\_\_\_\_ - \_\_\_\_\_ - \_\_\_\_\_ - \_\_\_\_\_ - \_\_\_\_\_ - \_\_\_\_\_  
 Model      (A) DIAMETER      (B) HEIGHT      (C) SUSPENSION & CANOPY      (D) FINISH 1      (E) FINISH 2      (F) OUTPUT      (G) LAMPING      (H) OPTION CODE

EXAMPLE ORDER CODE: R-0010 - 42 X 36 - S W - 058 - 001 - H - 35 - XD 92



24" diameter X 34" Height - Cable Suspension  
- Frosted Polymer Side - Brushed Brass structure - 2700K



24" diameter X 8" Height - Cable Suspension  
- Frosted Polymer Side - Walnut structure - 2700K

(A) DIAMETER

Specify the Diameter in inches, even number 16 - 50



(B) HEIGHT

Specify the Height in inches, even number 6 - 48

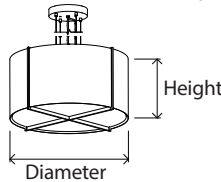

(C) SUSPENSION & CANOPY



1 Type of Suspension

<b>C</b>	Cable Suspension
<b>R</b>	Rigid Stem
<b>S</b>	Seismic Rigid Stem*

Standard drop length is 72" and is field cuttable. See section H for longer drop length option.

\*Seismic Rigid Stem allows for a 45° swivel.

2 Color of Canopy and Cord/Stem

<b>W</b>	White
<b>B</b>	Black
<b>R</b>	Brushed Brass
<b>A</b>	Brushed Aluminum

Blacked out squares indicate size combinations not offered.

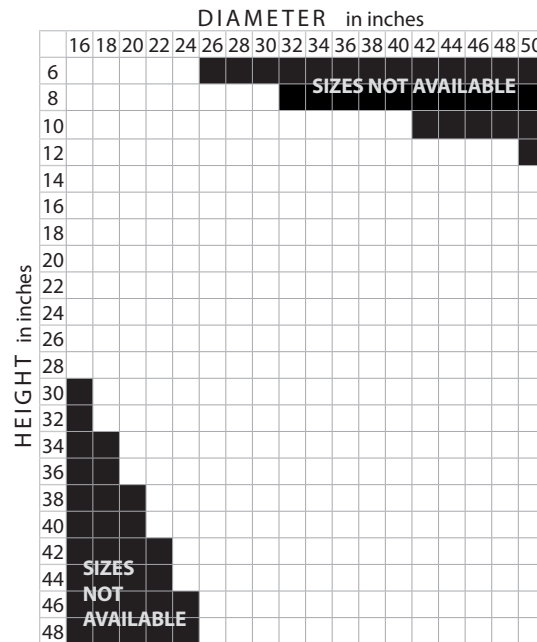

(D) FINISH 1 - SIDE PANELS

Translucent Side Panels

**051** Frosted polymer

Opaque Side Panels

**085** Matte Black

**012** Brushed Aluminum

**047** Brushed Brass

**096** Distressed Brass

**046** Brushed Rose Gold

**054** Gloss White

See page 3 for color swatches.

(E) FINISH 2 - STRUCTURE

Wood Structure

**001** Walnut

**002** Dark Stained Walnut

**095** White Washed Oak

Metal Structure

**006** Brushed Aluminum

**071** Brushed Brass

**114** Semigloss Black

**115** Semigloss White

(F) OUTPUT

<b>N</b>	Normal Output
<b>H</b>	High Output

See page 2 for output based on size of fixture and dimming information.

(G) LAMPING CCT

<b>27</b>	2700K LED
<b>30</b>	3000K LED
<b>35</b>	3500K LED
<b>40</b>	4000K LED

CRI 90+

R9 values 85+

(H) OPTION CODE

**XD** For custom drop lengths add "XD" followed by desired *Overall Height* in inches at end of order code. Otherwise a standard 72" drop length is provided which is field cuttable.

**EM** Emergency Backup option. See page 2 for emergency backup details.

See page 3 for color swatches.



Lumen Output based on Diameter and Height combination

Relative shape and scale

**N** Normal Output  
**H** High Output

		DIAMETER in inches																		
		16	18	20	22	24	26	28	30	32	34	36	38	40	42	44	46	48	50	
HEIGHT in inches	6																			
	8																			
	10																			
	12																			
	14																			
	16																			
	18																			
	20																			
	22																			
	24																			
	26																			
	28																			
	30																			
	32																			
	34																			
	36																			
38																				
40																				
42																				
44																				
46																				
48																				

Source Lumens listed.

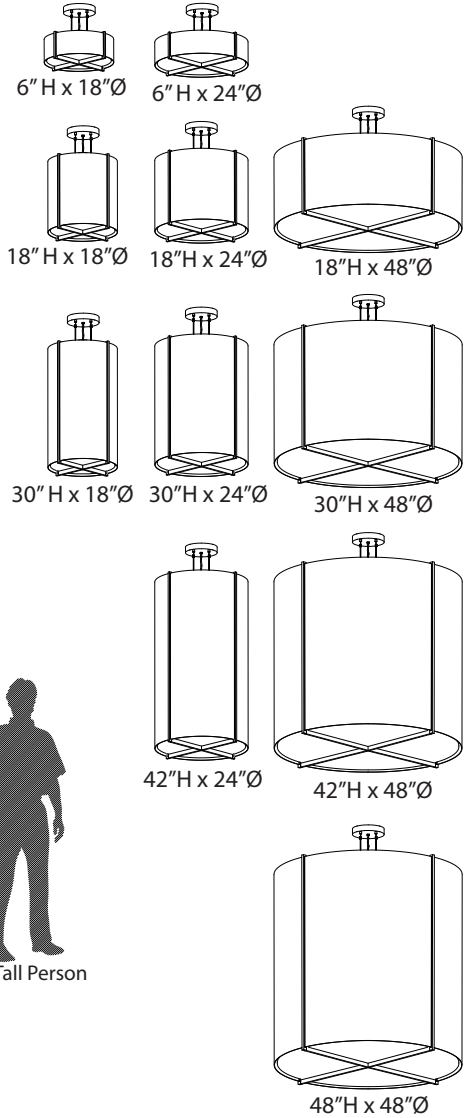

Dimming Performance

120 V AC input:  
0-10 V - 1% dimming  
TRIAC, ELV - 10% dimming (may achieve as low as 1% depending on dimmer)

240 & 277 V AC input:  
0-10 V - 1% dimming

Suspension

4 steel aircraft cables with SVT electrical cord.

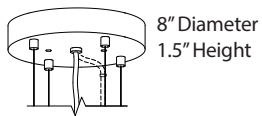

Rigid Stem

Canopy down stem is field cuttable to shorten.

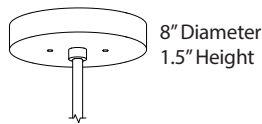

Seismic Rigid Stem

Canopy down stem is field cuttable to shorten.

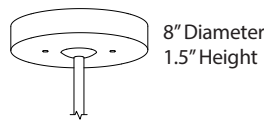

Allows for 45° swivel.

Emergency Backup

Emergency LED driver provided:  
100-277VAC input  
750 Lumens  
90 minutes of battery life  
Includes mounted test switch





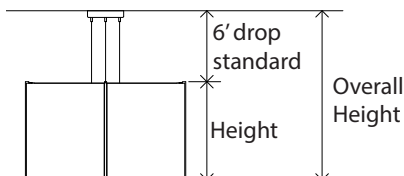

Detail - Brass Structure - Polymer Side

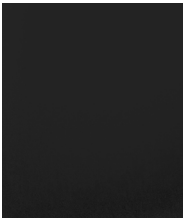

Fixture Elevation



Finish 1 - SIDE PANELS

Translucent		Opaque					
							
051 Frosted Polymer CM - 051	085 Matte Black CM - 085	012 Brushed Aluminum CM - 012	047 Brushed Brass CM - 047	096 Distressed Brass CM - 096	046 Brushed Rose Gold CM - 046	054 Gloss White CM - 054	

Finish 2 - STRUCTURE

Wood			Metal			
						
001 Walnut CM - 001	002 Dark Stained Walnut CM - 002	095 White Washed Oak CM - 095	006 Brushed Aluminum CM - 006	071 Brushed Brass CM - 071	114 Semigloss Black CM - 114	115 Semigloss White CM - 115