

Project Contact

Fill in the shaded boxes using the information listed below

Order Code	R-0050	-		-		-		-		-		-			
Model	R		A SUSPENSION		B EXTERIOR SHADE FINISH		C INTERIOR SHADE FINISH		D LIGHT ENGINE DISC		E LAMPING CCT		F LIGHT OUTPUT		G OPTION CODE
EXAMPLE ORDER CODE	R-0050	-	R	-	049	-	060	-	001	-	30	-	F	-	EM



Torrey pendant, corded, textured black outside, distressed brass inside, walnut light engine disc, 3000 K.



Torrey pendant, corded, textured white outside, textured white inside, white washed oak light engine disc, 3000 K.

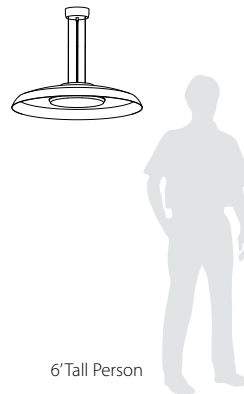
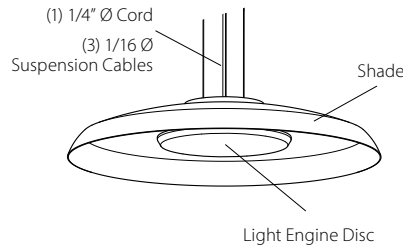
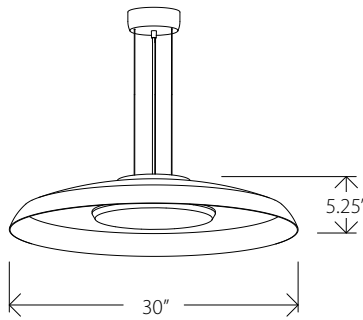

A SUSPENSION

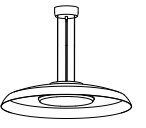
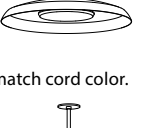
- W** Corded White 
- B** Corded Black 

Canopy color will match cord color.

- R** Rigid Stem 

Rigid stem and canopy matches finish of shade exterior.

B EXTERIOR SHADE FINISH

- 049** Textured Black
- 060** Textured White
- 119** Brushed Aluminum
- 120** Brushed Brass
- 117** Distressed Brass

C INTERIOR SHADE FINISH

- 060** Textured White
- 119** Brushed Aluminum
- 120** Brushed Brass
- 117** Distressed Brass

*finish will reduce delivered lumens.

D LIGHT ENGINE DISC

- 001** Walnut
- 002** Dark Stained Walnut
- 095** White Washed Oak
- 049** Textured Black
- 060** Textured White
- 119** Brushed Aluminum
- 120** Brushed Brass
- 117** Distressed Brass

E LAMPING CCT

- 27** 2700K LED
 - 30** 3000K LED
 - 35** 3500K LED
 - 40** 4000K LED
- CRI 90+

F LIGHT OUTPUT

- F** Full Output - Wattage
 - R** 50% Reduced Output - Wattage
 - C** Custom Reduction Percentage
- Full output:
2275 Lumens (delivered)
37 Watts

Custom Reduction Percentage to reduce both lumens and wattage.
Full output based on Textured White shade interior with 3000K.

G OPTION CODE

- XD** For custom drop lengths add "XD" followed by desired *Overall Height* in inches at end of order code. Otherwise a standard 72" drop length is provided which is field cuttable.
- EM** Emergency Backup option.



Fixture Specs

Dimensions: 30" Ø x 5.25"

Materials: Spun Aluminum Shade, Solid Wood or Spun Metal Accent,
Protective Powder Coated Finishes

Product weight: 13 lb

Light source: Integrated LED

Light output: 2275 Lumens (Textured White shade interior)

Color accuracy: 90+ CRI

Driver Specs

120-277 V AC Input

0-10 V dimming down to 1% with dim to off

LED driver integrated into fixture

Suspension

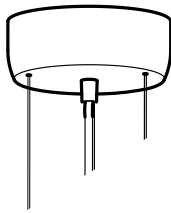

Corded Suspension
Canopy 5" Ø X 2"H

- Textured White (CM-060) or Textured Black (CM-049)
- 3 x 1/16" Stainless Steel Cables (CM-053)
- Field adjustable drop length: 1'0" min - 8'0" max
- Suitable for a sloped ceiling up to 30 degrees
- For extended cable length, please specify using XD designator in SKU builder
- 5-Conductor SVT Cable - color to match canopy (3 wires for AC power & ground, 2 wires for 0-10V dimming control)

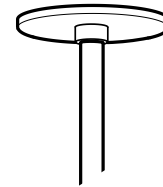

Rigid Suspension
Canopy 8" Ø X 0.38"H

- Stem and canopy finish to match exterior shade finish
- 0.5" Ø rigid stem
- Field cuttable: 1'0" min - 8'0" max
- Suitable for a sloped ceiling up to 30 degrees
- For extended stem length, please specify using XD designator in SKU builder
- White 5-Conductor SVT Cable inside rigid stem (3 wires for AC power & ground, 2 wire for 0-10V dimming control)

Photometric Polar Graph

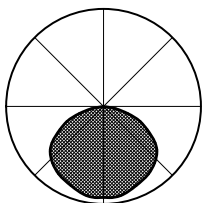

ⓑ EXTERIOR SHADE FINISH

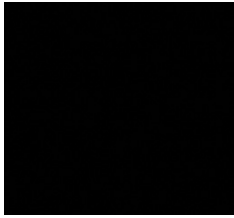

CM-049
Textured Black
Powder Coat

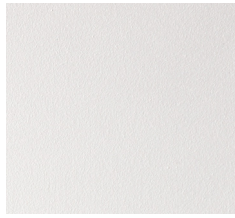

CM-060
Textured White
Powder Coat

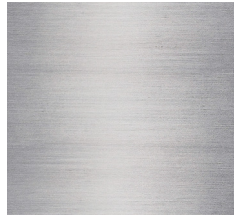

CM-119
Brushed Aluminum

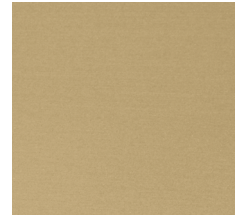

CM-120
Brushed Brass



CM-117
Distressed Brass

ⓒ INTERIOR SHADE FINISH



CM-060
Textured White
Powder Coat



CM-119
Brushed Aluminum

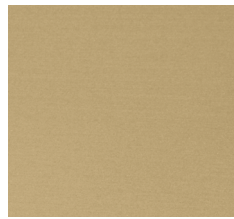

CM-120
Brushed Brass



CM-117
Distressed Brass

ⓓ LIGHT ENGINE DISC FINISH



CM-001
Walnut

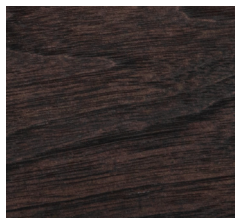

CM-002
Dark Stained Walnut



CM-095
White Washed Oak

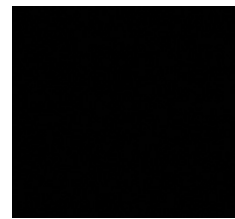

CM-049
Textured Black
Powder Coat



CM-060
Textured White
Powder Coat

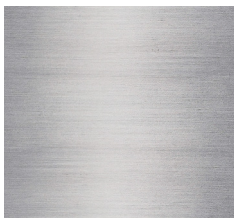

CM-119
Brushed Aluminum

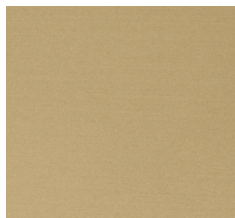

CM-120
Brushed Brass



CM-117
Distressed Brass