

cerno®



DESIGNED AND MADE IN CALIFORNIA

Spero Pendant



black / black leather



brass / brown leather



distressed brass / black leather



white / tan leather

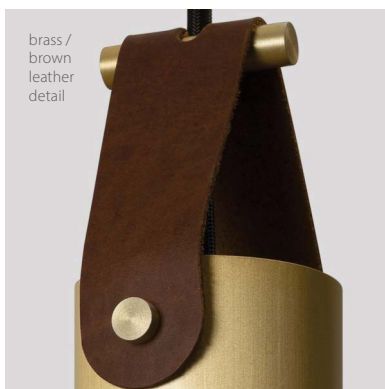

brass / brown leather detail



brass / tan leather detail

## Spero pendant

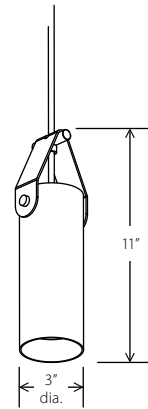

Dimensions: 3" dia., 11"  
 Product weight: 2 lb  
 "Field adjustable drop length: 0'6" min - 8'0" max  
 Canopy color matches cord"  
 Lamping: 1x E26 base, PAR20 lamp, 20 W max  
 Specifications subject to change



### MATERIAL & FINISH OPTIONS

Spero pendant part # 06-310- -

#### Standard Combinations

black / black leather  
 brass / brown leather  
 distressed brass / black leather  
 white / tan leather

B  
 R  
 D  
 W

#### Bulb Options

PAR20 LED bulb included - 2700 K, 90CRI,  
 40 degree flood  
 no bulb included

27  
 00

For expanded offering see Specification Sheet.

*The Spero Pendant illustrates a minimalist mindset without sacrificing design details that define the fixture. Pronounced metal accents join the leather strap to the shade, adding a balanced contrast between the different elements. The bottom aperture allows the delivery of ample light while shielding the rest of the space from glare.*

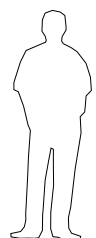

6' tall person

**⚠ WARNING.** California Proposition 65 Warning for California Consumers. This product can expose you to chemicals including wood dust and lead which are known to the State of California to cause cancer or birth defects or other reproductive harm. For more information go to [www.P65Warnings.ca.gov](http://www.P65Warnings.ca.gov)

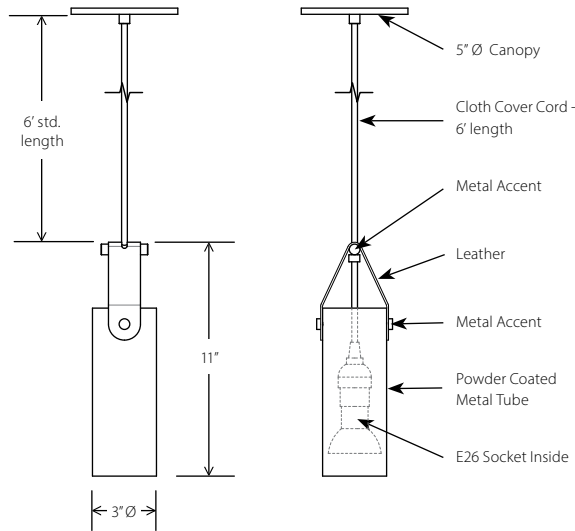

Standard combinations on the previous page are stocked. Fixture specified by using the SKU builder below are subject to increased lead times and minimum order quantities.

Spero Pendant part # 06-310-

**Shade Finish**

- textured black powder coat (CM-049)
- textured white powder coat (CM-060)
- brushed brass (CM-120)
- distressed brass (CM-117)

B  
W  
R  
D

**Metal Accent Finish**

- textured black powder coat (CM-049)
- textured white powder coat (CM-060)
- brushed brass (CM-120)
- distressed brass (CM-117)

B  
W  
R  
D

**Leather Finish**

- brown leather (CM-098)
- black leather (CM-127)
- tan leather (CM-128)

R  
B  
T

**Bulb Options**

- PAR20 LED bulb included - 2700 K, 90CRI, 40 degree flood, 6.5 W, 650 lumens
- no bulb included

27  
00

## PHOTOMETRIC POLAR GRAPH

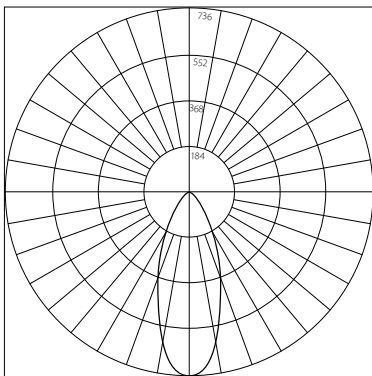

Maximum Candela = 736  
Located at  
Horizontal Angle = 0,  
Vertical Angle = 0

Output for 40 degree  
flood PAR20 bulb.  
Actual output will vary  
if a different bulb type  
is installed.

## TECHNICAL SPECIFICATIONS

- Light source: medium base E26 socket
- Lamping: 1x E26 base, PAR20 lamp, 20 W max
- Input Voltage: 250 V AC max
- Low profile round canopy with SVT-3 Cable
- Canopy dimensions: 5" Ø, 0.3"
- See website for more canopy information
- Field adjustable drop length: 0'6" min - 8'0" max
- White canopy and cord for fixtures with white shade exterior
- Black canopy and cord for all other finishes
- Suitable for a sloped ceiling up to 45 degrees
- Specifications subject to change



Included PAR20 LED bulb specifications (optional)

Light output: 520 Lumens (source)

Light color: 2700 K

Color accuracy: 90+ CRI

Power usage: 6.5 W

Dimmability: Triac or ELV

## FINISHES



textured black powder coat (CM-049)

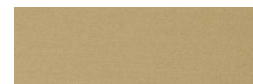

brushed brass (CM-120)

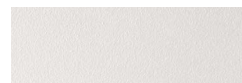

textured white powder coat (CM-060)



distressed brass (CM-117)

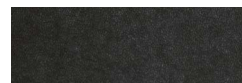

black leather (CM-127)

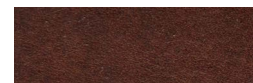

brown leather (CM-098)

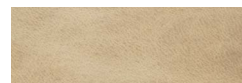

tan leather (CM-128)

**▲WARNING.** California Proposition 65 Warning for California Consumers. This product can expose you to chemicals including wood dust and lead which are known to the State of California to cause cancer or birth defects or other reproductive harm. For more information go to [www.P65Warnings.ca.gov](http://www.P65Warnings.ca.gov)