

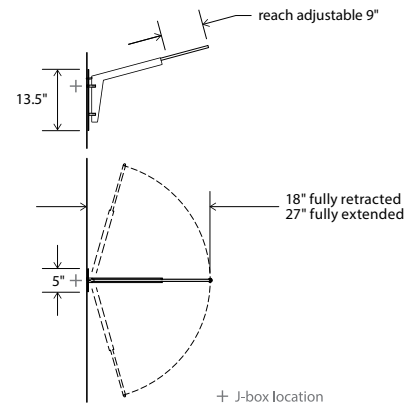

Motus swing arm bracket



Dimensions: 18.38" x 5" x 26.8"
 Materials: solid wood, metal
 Product weight: 3 lb
 Max suspension weight: 5 lb
 Swing arm length can be adjusted from 18" to 27"
 Max drop length from tip of extended arm to top of pendant is 36"
 Swing arm rotation has adjustable resistance in pivot hinge
 Wood grain will vary
 Specifications subject to change



brushed aluminum (CM-006)



textured black coat powder (CM-049)



walnut (CM-001)



dark stained walnut (CM-002)

HOW IT WORKS: BUILD YOUR OWN FIXTURE

Pick one of the pendants listed below and pair it with the Motus Swim Arm Bracket for a unique and versatile light fixture.

To order, you will need to select a SKU for the pendant that you choose and a SKU from the Motus Swing Arm Bracket.

The SKU builder for the Motus Swing Arm Bracket is above, and the SKU builders for the pendants are located on their respective tear sheets.

MATERIAL & FINISH OPTIONS

Motus part # 60-210-

Metal Finish

brushed aluminum (CM-006)
 textured black powder coat (CM-049)

A

B

Wood Body

walnut (CM-001)
 dark stained walnut (CM-002)

W

D

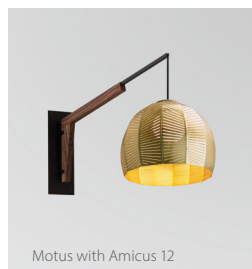
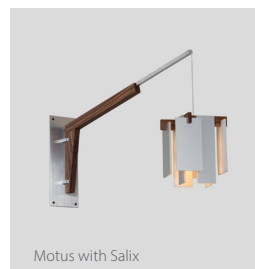
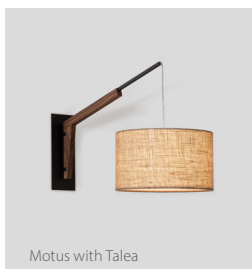
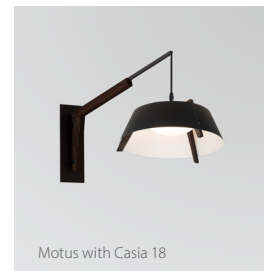
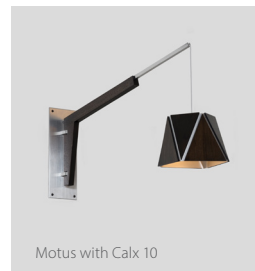
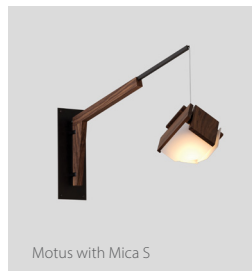
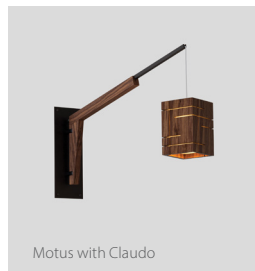
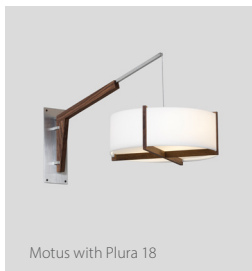

▲WARNING. California Proposition 65 Warning for California Consumers. This product can expose you to chemicals including wood dust and lead which are known to the State of California to cause cancer or birth defects or other reproductive harm. For more information go to www.P65Warnings.ca.gov