

## Merus vanity sconce

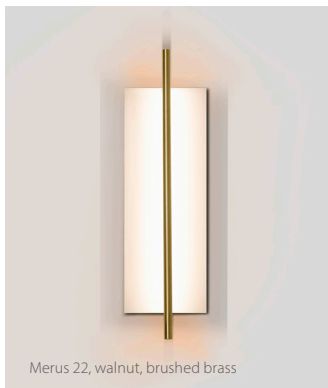

Merus 40, walnut, brushed aluminum



Merus 22, walnut, brushed brass



Details

*Merus is a quintessential Cerno design. Clean, modern lines paired with a novel indirect light source compose a form that balances beauty and usefulness. Our team used Cerno's signature material palette of wood and metal.*

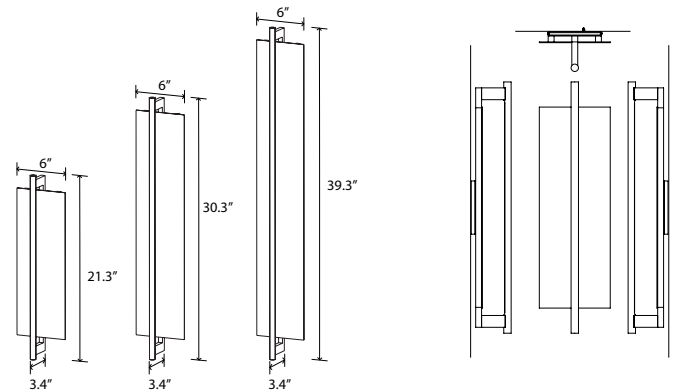
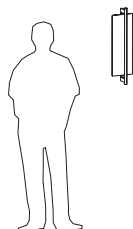

Merus 22 dimensions: 21.3" x 6" x 3.4"  
 Merus 31 dimensions: 30.3" x 6" x 3.4"  
 Merus 40 dimensions: 39.3" x 6" x 3.4"

Merus 22 weight: 2 lb  
 Merus 31 weight: 2 lb  
 Merus 40 weight: 3 lb

Light source: integrated LED  
 Merus 22 light output: 780 Lumens (source)  
 Merus 31 light output: 1170 Lumens (source)  
 Merus 40 light output: 1560 Lumens (source)  
 Light color: 2700 K, 3000 K, 3500 K or 4000 K  
 Color accuracy: 90+ CRI

Merus 22 power usage: 11 W  
 Merus 31 power usage: 16 W  
 Merus 40 power usage: 21 W  
 Dimmable (see driver below)  
 Driver location: must be housed in J-box  
 Merus 22 driver dimensions: 2.63" x 1.25" x 0.8", included  
 Merus 31 driver dimensions: 3.0" x 1.0" x 1.5", included  
 Merus 40 driver dimensions: 2.82" x 2.5" x 1.2", included  
 Wood grain will vary.  
 Specifications subject to change.  
 UL listed for damp locations.



### MATERIAL & FINISH OPTIONS

Merus part #: 03-251-	B	-
Size		
22"	22	
31"	31	
40"	40	
Wood Finish		
walnut (CM-001)	W	
dark stained walnut (CM-002)	D	
white washed oak (CM-095)	O	
Metal Finish		
brushed aluminum (CM-006)	A	
brushed brass (CM-120)	R	
Lamping		
2700 K LED	27	
3000 K LED	30	
3500 K LED	35	
4000 K LED	40	
Driver		
120 V AC input voltage		P1
TRIAC, ELV & 0-10 V dimming		
277 V AC input voltage		P2
TRIAC, ELV & 0-10 V dimming		

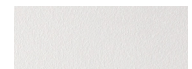

textured white (CM-060)

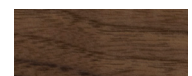

walnut (CM-001)

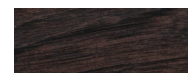

dark stained walnut (CM-002)



white washed oak (CM-095)



brushed aluminum (CM-006)

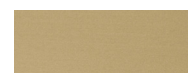

brushed brass (CM-120)

Includes: textured white (CM-060) reflector

**▲WARNING.** California Proposition 65 Warning for California Consumers. This product can expose you to chemicals including wood dust and lead which are known to the State of California to cause cancer or birth defects or other reproductive harm. For more information go to [www.P65Warnings.ca.gov](http://www.P65Warnings.ca.gov)