

Project Contact

Fill in the shaded boxes using the information listed below

Order Code **R-0070** - - - - - - -

Model **A** SUSPENSION **B** EXTERIOR SHADE FINISH **C** INTERIOR SHADE FINISH **D** LIGHT ENGINE DISC **E** LAMPING CCT **F** LIGHT OUTPUT **G** OPTION CODE

EXAMPLE ORDER CODE R-0070 - R 049 - 060 - 001 - 30 - F - EM



Loma pendant, corded, textured white outside, textured white inside, white washed oak light engine disc, 2700 K.



Loma pendant, corded, textured black outside, distressed brass inside, dark stained walnut light engine disc, 2700 K.

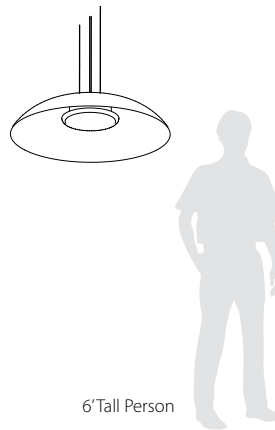
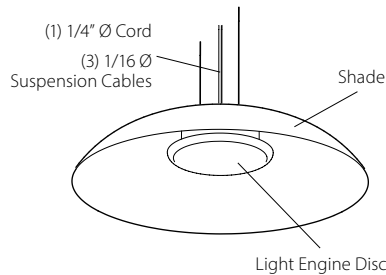
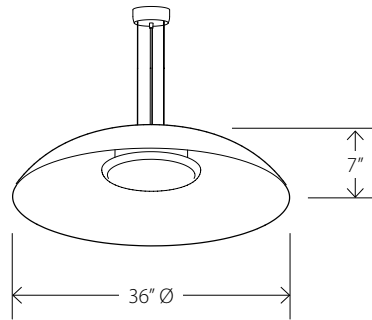

A SUSPENSION

W Corded White
B Corded Black
Canopy color will match cord color.

R Rigid Stem
Rigid stem and canopy matches finish of shade exterior.

B EXTERIOR SHADE FINISH

- 049** Textured Black
- 060** Textured White
- 119** Brushed Aluminum
- 120** Brushed Brass
- 117** Distressed Brass

C INTERIOR SHADE FINISH

- 060** Textured White
- 119** Brushed Aluminum
- 120** Brushed Brass
- 117** Distressed Brass

*Different finishes may reduce deliver lumens.

D LIGHT ENGINE DISC

- 001** Walnut
- 002** Dark Stained Walnut
- 095** White Washed Oak
- 049** Textured Black
- 060** Textured White
- 119** Brushed Aluminum
- 120** Brushed Brass
- 117** Distressed Brass

E LAMPING CCT

- 27** 2700K LED
 - 30** 3000K LED
 - 35** 3500K LED
 - 40** 4000K LED
- CRI 90+

F LIGHT OUTPUT

- F** Full Output - Wattage
 - R** 50% Reduced Output - Wattage
 - C** Custom Reduction Percentage
- Full output: 2481 Lumens (delivered)
36 Watts

Full output based on Textured White shade interior and 2700 K LED.
Custom Reduction Percentage - to reduce both lumens and wattage.

G OPTION CODE

- XD** For custom drop lengths add "XD" followed by desired Overall Height in inches at end of order code. Otherwise a standard 72" drop length is provided which is field cuttable.
- EM** Emergency Backup option.



Fixture Specs

Dimensions: 36" dia, 7"
 Materials: Spun Aluminum Shade, Solid Wood or Spun Metal
 Accent, Protective Powder Coated Finishes
 Product weight: 19 lb
 Light source: integrated LED
 Light output: 2481 Lumens (delivered)
 Color accuracy: 90+ CRI

Driver Specs

AC Input Voltage Range: 120-277 V
 0-10V dimming down to 1% with dim to off
 LED driver integrated into fixture

Suspension

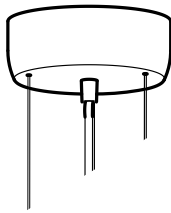

Corded Suspension
 Canopy 5" Ø X 2"H

- Textured White (CM-060) or Textured Black (CM-049)
- 3x 1/16" Stainless Steel Cables (CM-053)
- Field adjustable drop length: 1'0" min - 8'0" max
- Suitable for a sloped ceiling
- For extended cable length, please specify using XD designator in SKU builder
- 5-Conductor SVT Cable - color to match canopy (3 wires for AC power & ground, 2 wires for 0-10V dimming control)

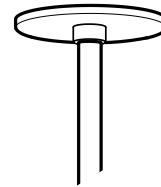

Rigid Suspension
 Canopy 5" Ø X 0.3"H

- Stem and canopy finish to match exterior shade finish
- 0.5" Ø rigid stem
- Field cuttable: 1'0" min - 8'0" max
- For extended stem length, please specify using XD designator in SKU builder
- White 5-Conductor SVT Cable inside rigid stem (3 wires for AC power & ground, 2 wire for 0-10V dimming control)

Photometric Polar Graph

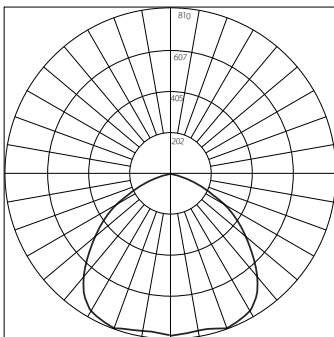

Maximum Candela = 809
 Located at:
 Horizontal Angle = 140
 Vertical Angle = 20

ⓑ EXTERIOR SHADE FINISH

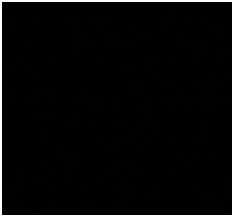

CM-049
Textured Black
Powder Coat



CM-060
Textured White
Powder Coat



CM-119
Brushed Aluminum

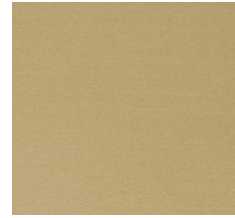

CM-120
Brushed Brass



CM-117
Distressed Brass

ⓒ INTERIOR SHADE FINISH



CM-060
Textured White
Powder Coat



CM-119
Brushed Aluminum

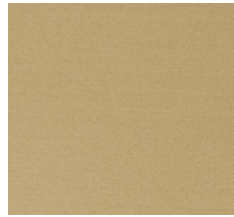

CM-120
Brushed Brass



CM-117
Distressed Brass

ⓓ LIGHT ENGINE DISC FINISH

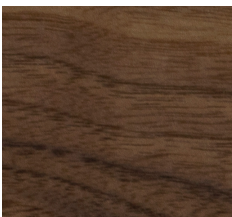

CM-001
Walnut

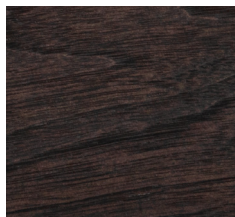

CM-002
Dark Stained Walnut



CM-095
White Washed Oak

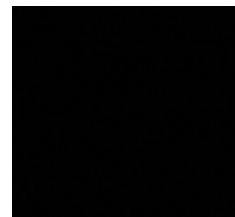

CM-049
Textured Black
Powder Coat

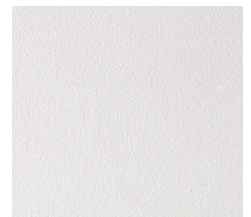

CM-060
Textured White
Powder Coat



CM-119
Brushed Aluminum

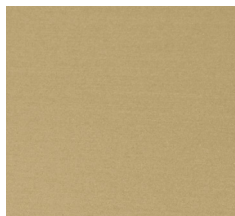

CM-120
Brushed Brass



CM-117
Distressed Brass