

cerno®

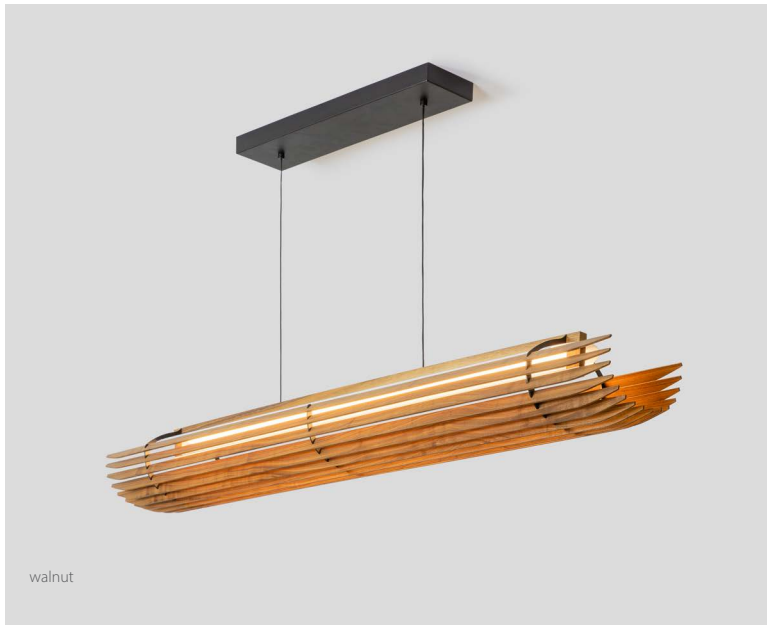

DESIGNED AND MADE IN CALIFORNIA

Lex Linear Pendant



walnut



white washed oak, side and under view



walnut, under view

The Lex Linear Pendant embodies our love and respect for the ocean and the crafts that sail on her waters. It shares many elements of a well-made vessel. The three bulkheads capture and guide the fifteen slats, creating a dynamic and robust structure. As you walk around the Lex, the massing changes with each step and new perspective. The indirect light source delivers a beautiful quality and meaningful amount of light while also eliminating an opportunity for glare.

Lex linear pendant

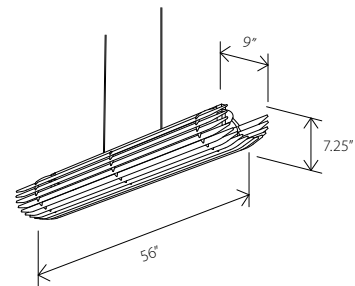

Dimensions: 56" x 9" , 7.25" H
 Product weight: 8 lb
 Light source: integrated LED
 Light output: 1845 Lumens (source)
 Light color: 2700 K, 3000 K, 3500 K, or 4000 K
 Color accuracy: 90+ CRI
 Power usage: 17 W
 Dimmable (see driver section below)
 Wood grain will vary
 Specifications subject to change



MATERIAL & FINISH OPTIONS

Lex linear pendant part # 07-240-

Standard Finish Combinations

walnut (CM-001) / black (CM049)
 dark stained walnut (CM-002) /
 black (CM-049)
 white washed oak (CM-095) /
 white (CM-060)

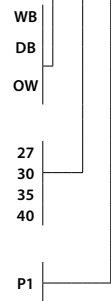

Lamping

2700 K LED
 3000 K LED
 3500 K LED
 4000 K LED

Driver

120-277 V AC input voltage
 TRIAC, ELV & 0-10 dimming

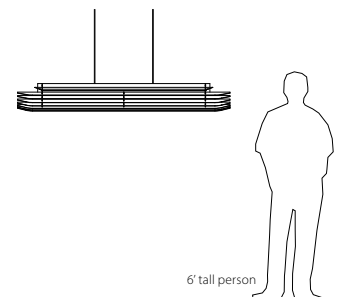

6' tall person

▲WARNING. California Proposition 65 Warning for California Consumers. This product can expose you to chemicals including wood dust and lead which are known to the State of California to cause cancer or birth defects or other reproductive harm. For more information go to www.P65Warnings.ca.gov

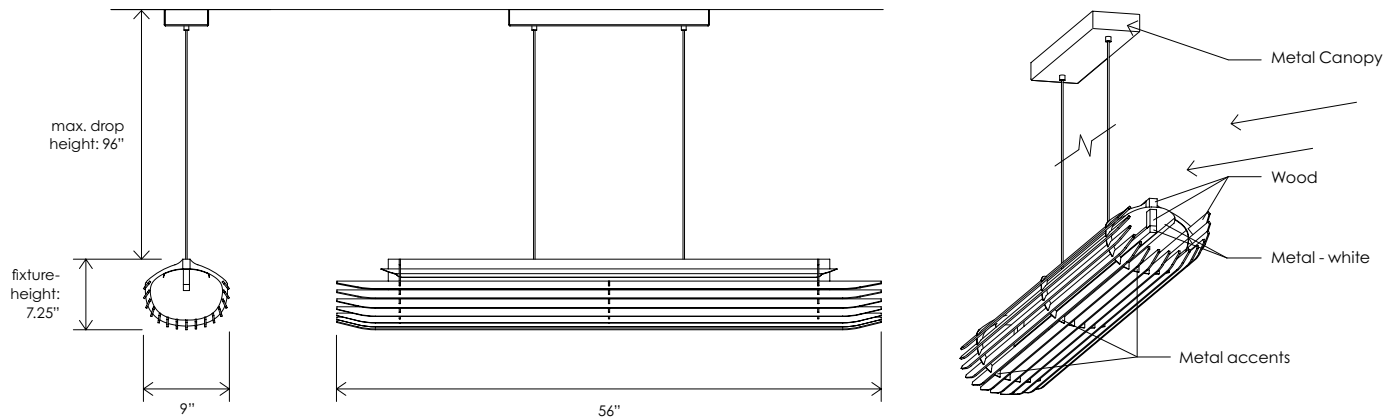

TECHNICAL SPECIFICATIONS

Materials: solid wood, aluminum, steel
 Light source: integrated LED
 Light output: 1845 Lumens (source)
 Light color: 2700 K, 3000 K, 3500 K, or 4000 K
 Color accuracy: 90+ CRI
 Input Voltage: 120-277 V AC
 Power usage: 25 W
 Dimmability: TRIAC, ELV & 0-10 V dimming
 Canopy dimensions: 20.5" x 4.4", 1.7"
 Drop length field adjustable: 0'-10" min, 8'-0" max
 Wood canopy covers are available:
 Walnut (CM-001) cover: part # 60-241-001W
 Dark Stained Walnut (CM-002) cover: part # 60-241-001D
 White Washed Oak (CM-095) cover: part # 60-241-001O
 Suitable for a sloped ceiling up to 45 degrees
 Driver to be housed in canopy
 Driver dimensions: 3.6" Ø, 1.3" h, included
 Specifications subject to change



PHOTOMETRIC POLAR GRAPH

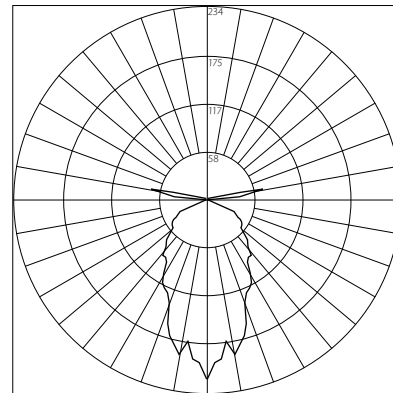

Maximum Candela = 233.61
 Located at Horizontal Angle = 75, Vertical Angle = 2.5

Output specifications shown for 2700K CCT and walnut shade with black accents for vertical plane through 0-180 degree horizontal angles. Other CCTs and material finishes may cause output specifications to vary.

FINISHES



walnut (CM-001)

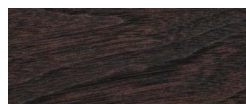

dark stained walnut (CM-002)



white washed oak (CM-095)



textured black (CM-049)

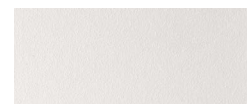

textured white (CM-060)