

cerno®



D E S I G N E D   A N D   M A D E   I N   C A L I F O R N I A





## BELIEF

With no backyards but access to beaches and idyllic doses of salt and sun, our business story began with the adventures of three boys. Laguna Beach's creative culture and natural environment shaped our professional and aesthetic ideals. Looking back it's now clear that our childhood projects and experiments grew into our best adventure yet: building Cerno.



## THE BEGINNING



*Cerno founders, 1998. Left to right: Nick Sheridan, Dan Wacholder, Bret Englander.*

Our drive and influences come from many different sources. One source that influenced all of us is Daniel's late grandfather, Steve. Steve grew up on a remote homestead where the existence of most objects depended on people's ability to create and fix them. For all of his 101 years, he embodied the saying "where there's a will, there's a way." On the California coast we were raised with this mentality and today we share it with the rest of the Cerno team.

## CERNO

- Verb (Latin)

1. To resolve, distinguish, decide, sift, determine, to perceive.







# Table of Contents

## OUR TEAM

Each finished product is a celebration of the inventive minds and industrious hands that brought it to life. Dreams do not manifest themselves; skilled people bring dreams to life. The passion of our steadily growing team and their commitment to the product is inspiring. We are grateful for every individual that is part of our collaborative creative process.

<b>Floor</b>	<b>9</b>	<b>Scences</b>	<b>55</b>
Fons 8 / Fons 10	10	Talea	57
Valeo	11	Via	58
Nauta Floor	14	Calx	59
Silva Floor	15	Vesper	61
Forma	16	Acuo	62
Altus	17	Capio S	64
Silva Giant	18	Capio L	64
<b>Linear Pendants</b>	<b>21</b>	Tersus	68
Lenis	23	Sedo	69
Arca	24	Ansa	71
Camur	25	Fortis	72
Aeris 30 / Aeris 54	27	Claudo	73
Vix 34 / Vix 48	29	Cubo	74
Vix 82	31	Libri	75
Virga	32	Levo	77
Brevis 28 / Brevis 42	33	Levo Shelf Option	77
<b>Pendants</b>	<b>35</b>	<b>Table</b>	<b>79</b>
Muto	36	Forma Table	80
Imber 17 / Imber 24	38	Nauta Table	81
Ignis 17 / Ignis 24	39	Silva	82
Ico	41	Macto	83
Calx 10 / Calx 19	42	<b>Revelite AL</b>	<b>85</b>
Calx 36	43	Accessories	86
Abeo	44	Motus Swing Arm Bracket	86
Claudo	45	Canopy Accessories	86
Mica	47	Finish and Material Options	87
Mica L	47		
Levis	48		
Levis L	48		
Salix	49		
Plura Pendant	51		
Plura Flush Mount	53		





## Floor

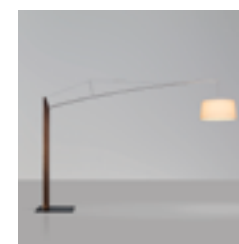

Fons Family



Valeo



Silva Giant



Silva Floor



Forma



Altus



**Fons 8 / Fons 10**  
floor

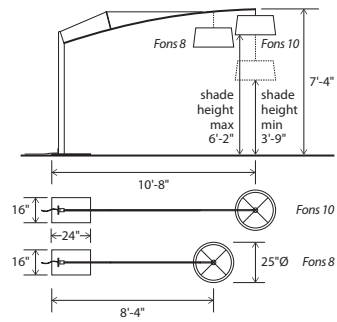

Dimensions: 25" Ø shade, 7'-4"  
 Materials: solid wood, metal, linen shade  
 Product weight: 65 lb  
 Light source: medium base E26 socket  
 Lamping: E26 base, type A lamp, 60 W max  
 Input voltage: 120 V AC max  
 Includes 6'-0" clear silver cord with inline foot switch 24" from base  
 Bottom diffuser included (CM-051)  
 Wood grain will vary  
 Specifications subject to change



Included dimmable LED A19 bulb  
 Light output: 800 Lumens (source)  
 Light color: 2700 K  
 Color accuracy: 90+  
 Power usage: 11 W

**MATERIAL & FINISH OPTIONS**

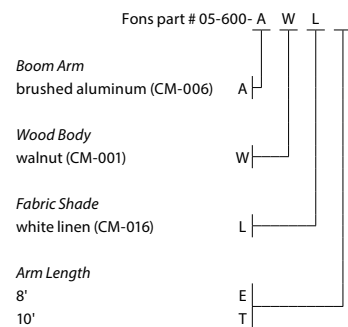

**Includes**  
 stainless steel tension cable (CM-053)  
 black powder coated steel base (CM-049)  
 frosted polymer diffuser (CM-051)

Alternate voltage/plug styles are available



**ARM LENGTH**  
 Available in 10'-8" and 8'-4" arm lengths  
 Arm length is from back of base to center of shade  
 Arm lengths are not adjustable

**SHADE HEIGHT**  
 Shade height (floor to bottom edge of shade) can be adjusted between 6'-2" maximum and 3'-9" minimum.

*The goal with the Fons was to minimize the structure and visual massing of the fixture while maximizing the reach or cantilever. The delicate boom arm, upheld by a tension cable, gently bends while reaching out to almost horizontal where it suspends the light. The structural design is an extremely effective way to resolve the forces associated with such a long reach. It is so effective and efficient that it seems to float with a weightlessness at the tip.*

Nick Sheridan  
 Designer

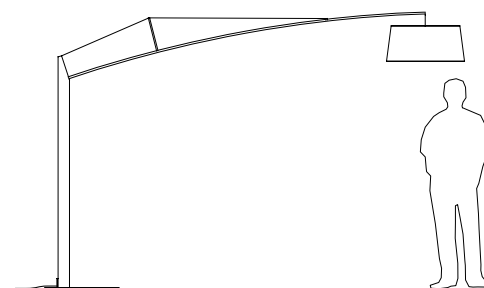

**Valeo**  
floor

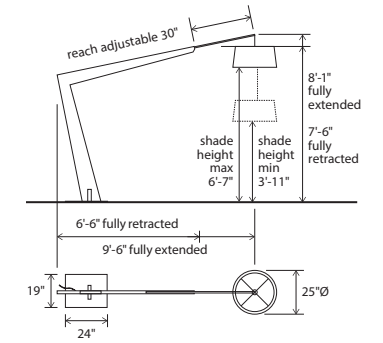

Dimensions: 8'1" H max, 25" Ø shade  
 Materials: solid wood, metal, linen shade  
 Product weight: 95 lb  
 Light source: medium base E26 socket  
 Lamping: E26 base, type A lamp, 60 W max  
 Input voltage: 120 V AC max  
 Includes 72" clear silver cord with inline foot switch 24" from base  
 Bottom diffuser included (CM-051)  
 Wood grain will vary  
 Specifications subject to change



Included dimmable LED A19 bulb  
 Light output: 800 Lumens (source)  
 Light color: 2700 K  
 Color accuracy: 90+ CRI  
 Power usage: 11 W

**MATERIAL & FINISH OPTIONS**

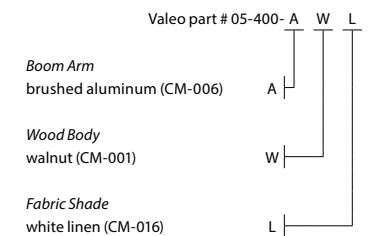

**Includes**  
 black powder coated steel base (CM-049)  
 frosted polymer diffuser (CM-051)

Alternate voltage/plug styles are available

*When reaching such a distance with a fixture, it is important that it feels visually efficient in its form but is still far from fragile, inviting one to linger under it. The adjustability in the reach and the height of the shade make it possible to custom fit the piece to its surroundings - an important characteristic for such a large piece.*

Nick Sheridan  
 Designer

**ARM LENGTH**  
 Arm length (from back of base to center of shade) can be adjusted between 9'-6" maximum and 6'-6" minimum.

**SHADE HEIGHT**  
 Shade height (floor to bottom edge of shade) can be adjusted between 6'-7" maximum and 3'-11" minimum.

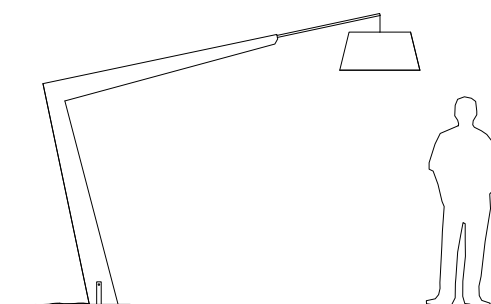







in collaboration with  
**DESIRON FRANK CARFARO**  
HAND CRAFTED AMERICAN FURNITURE

**Nauta Floor**  
floor

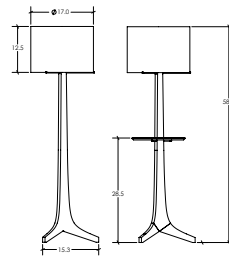

Dimensions: 17" Ø, 59"  
Materials: solid wood, aluminum, fabric shade  
Product weight: 8 lb  
Light source: medium base E26 socket  
Lamping: E26 base, 60 W max  
Input voltage: 250 V AC max  
Includes 8' clear silver cord with white plug  
On/Off rocker switch on socket  
Wood grain will vary  
Specifications subject to change  
**SHELF IS OPTIONAL**  
UL  
Included dimmable LED A19 bulb  
Light output: 800 Lumens (source)  
Light color: 2700 K  
Color accuracy: 90+ CRI  
Power usage: 11 W

**MATERIAL & FINISH OPTIONS**

Nauta Floor part #: 05-110-

**Metal Finish**

- brushed aluminum (CM-006) A
- brushed brass (CM-008)\* R

**Wood Body**

- walnut (CM-001) W
- dark stained walnut (CM-002) D
- white washed oak (CM-095) O

**Shade**

- black amaretto (CM-018) A
- white linen (CM-016) L
- burlap (CM-017) N

**Optional Shelf Accessory**

- no shelf N
- matching wood shelf - exposed wood top surface M
- matching wood shelf - black HPL top surface (CM-092) B
- matching wood shelf - white HPL top surface (CM-093) W

\*Brass shade support arms feature wood plug in end of arm

\*\*Shelf is optional and cannot be removed by customer



black amaretto (CM-018)



white linen (CM-016)



burlap (CM-017)

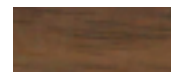

walnut (CM-001)

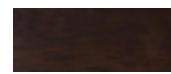

dark stained walnut (CM-002)



white washed oak (CM-095)



brushed brass (CM-008)

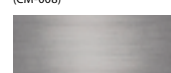

brushed aluminum (CM-006)



walnut, brushed aluminum, burlap

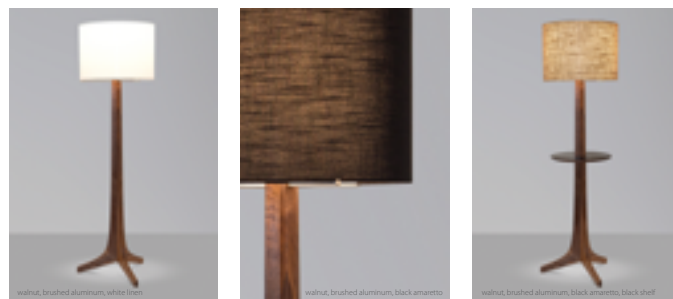

Efficiency and simplicity guided the design process for the Nauta table lamp. We designed the Forma several years ago with Frank Carfaro of Desiron, which profoundly influenced the Nauta's form. Our goal was to distill the Forma design without compromising it. The Nauta is clean, modern, and priced competitively.

Nick Sheridan  
Designer

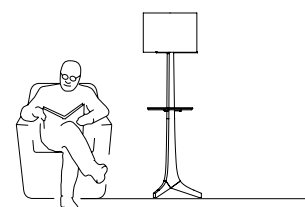

Silva Floor, walnut body, ebony eco veneer shade



Silva Floor, walnut, beech wood veneer shade

Silva Floor, walnut, white linen shade

The Silva Floor is slender, elegant, and poised while delivering great functionality. The tri-leg base finds stability on uneven surfaces and allows the cord to exit discreetly and effectively. It feels signature and iconic while still keeping a clean and timeless modern aesthetic.

Nick Sheridan  
Designer

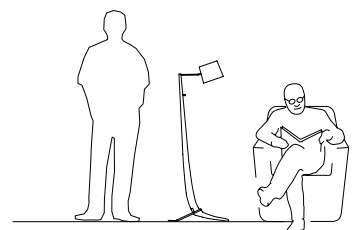

**Silva Floor**  
floor

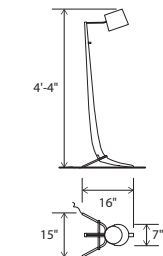

Dimensions: 16" x 15", 4'-4"  
Materials: solid wood, aluminum, bent shade  
Articulating head  
Product weight: 4 lb  
Light source: integrated LED  
Light output: 565 Lumens (source)  
Light color: 2700 K  
Color accuracy: 90+ CRI  
Power usage: 7 W  
Input voltage: 12V DC (adapter included)  
Includes 72" white braided cord  
Dimmable on fixture  
Wood grain will vary  
Specifications subject to change  
UL



beech wood veneer (CM-019)



ebony eco veneer (CM-020)



white linen (CM-058)

**MATERIAL & FINISH OPTIONS**

Silva Floor part # 05-100- A W

**Metal Finish**

- brushed aluminum (CM-006) A

**Wood Body**

- walnut (CM-001) W

**Bent Shade**

- beech wood veneer (CM-019) B
- ebony eco veneer (CM-020) E
- white linen (CM-058) L

Alternate voltage/plug styles are available  
Also available in larger version, see page 14, and smaller version, see page 74.



in collaboration with  
**DESIRON FRANK CARFARO**  
HAND CRAFTED AMERICAN FURNITURE

**Forma**  
floor

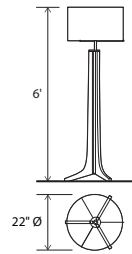

Dimensions: 22" Ø shade, 6'  
Materials: solid wood, aluminum, fabric shade  
Product weight: 15 lb  
Light source: medium base E26 socket  
Lamping: E26 base, type A lamp, 60 W max  
Input voltage: 120 V AC max  
Dimmable on fixture  
Wood grain will vary  
Specifications subject to change



Included dimmable LED A19 bulb  
Light output: 800 Lumens (source)  
Light color: 2700 K  
Color accuracy: 90+ CRI  
Power usage: 11 W

MATERIAL & FINISH OPTIONS

Forma Floor part # 05-300-

**Metal Finish**

- brushed aluminum (CM-006) A
- black anodized aluminum (CM-007) B

**Wood Body**

- walnut (CM-001) W
- dark stained walnut (CM-002) D
- maple (CM-005) M

**Fabric Shade**

- burlap (CM-017) N
- white linen (CM-016) L
- black amaretto (CM-018) A

Alternate voltage/plug styles are available  
Also available in smaller version, see page 73.



*Frank Carfaro and I worked to design a piece that embraced both Cerno and Desiron's aesthetic, without deviating too much from either brand's design language. I am really pleased with the fluidity, posture and scale we achieved with the Forma.*

Nick Sheridan  
Co-Designer

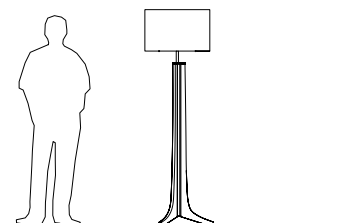

in collaboration with  
**DESIRON FRANK CARFARO**  
HAND CRAFTED AMERICAN FURNITURE

**Altus**  
floor

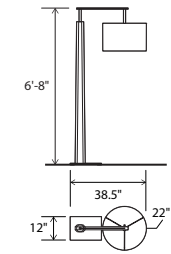

Dimensions: 6'-8" H, 22" Ø shade  
Materials: solid wood, metal, fabric shade  
Product weight: 45 lb  
Light source: medium base E26 socket  
Lamping: E26 base, type A lamp, 60 W max  
120 V AC max  
Dimmable on fixture  
Wood grain will vary  
Specifications subject to change



Included dimmable LED A19 bulb  
Light output: 800 Lumens (source)  
Light color: 2700 K  
Color accuracy: 90+ CRI  
Power usage: 11 W

MATERIAL & FINISH OPTIONS

Altus part # 05-700-

**Metal Finish**

- brushed brass (CM-008) R
- distressed brass (CM-009) D
- oiled bronze (CM-010) Z

**Wood Body**

- walnut (CM-001) W
- dark stained walnut (CM-002) D

**Fabric Shade**

- burlap (CM-017) N
- white linen (CM-016) L
- black amaretto (CM-018) A

Alternate voltage/plug styles are available

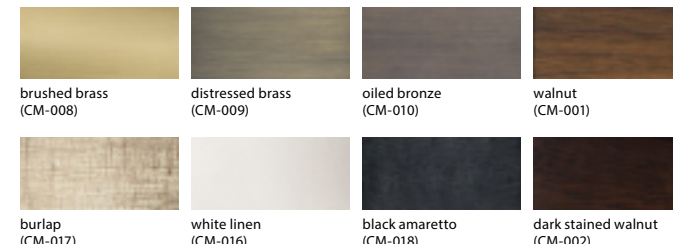

*The Altus is a robust fixture that also carries an air of elegance and subtle proportion. It has the mass and impact to anchor a space while still showing balance and grace. It is always exciting to see how the solid wood trunk comes out; admiring the wood grain all the way through.*

Nick Sheridan  
Co-Designer

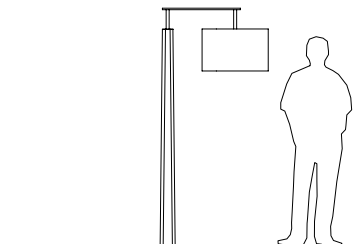



**Silva Giant**  
floor

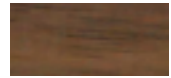
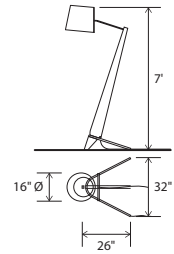

walnut  
(CM-001)

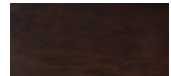

dark stained walnut  
(CM-002)

Dimensions: 32" x 26", 7', 16" Ø shade  
 Materials: solid wood, aluminum, linen shade  
 Product weight: 60 lb  
 Light source: medium base E26 socket  
 Lamping: E26 base, type A lamp, 60 W max  
 Input voltage: 120 V AC max  
 Includes 72" clear silver cord with  
 inline foot switch 24" from base  
 Bottom diffuser included (CM-057)  
 Wood grain will vary  
 Specifications subject to change



Included dimmable LED A19 bulb  
 Light output: 800 Lumens (source)  
 Light color: 2700 K  
 Color accuracy: 90+ CRI  
 Power usage: 11 W

**MATERIAL & FINISH OPTIONS**

	Silva Giant part # 05-200-	A	L
<b>Metal Finish</b>			
brushed aluminum (CM-006)		A	
<b>Wood Body</b>			
walnut (CM-001)		W	
dark stained walnut (CM-002)		D	
<b>Fabric Shade</b>			
white linen (CM-058)			L

Alternate voltage/plug styles are available  
 Also available in 2 smaller versions  
 See pages 15 and 74.



Silva Giant, brushed aluminum, walnut body, white linen shade

*The Silva Giant, as the name suggests, is a giant version of our Silva table fixture. Its scale gives it a strong presence even in very large spaces, while its distilled form gives it a simplicity that can be seen from across the room. A fun piece with a huge personality.*

Nick Sheridan  
 Designer

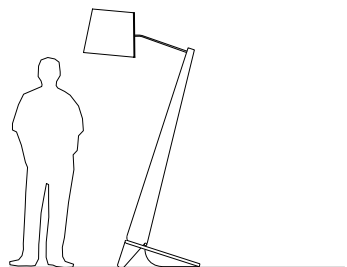





## Linear Pendants



Lumis



Lumis



Vix



Vix



Arca



Camur



Vix 82



Vix 82



Aeris



Aeris



Virga



Brevis





Lenis, brushed aluminum



**Lenis**  
linear pendant

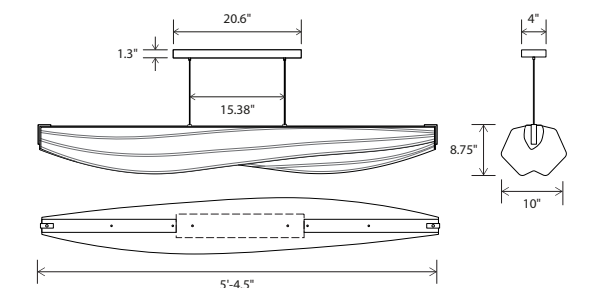

Dimensions: 5'-4.5" x 10", 8.75"  
 Materials: aluminum, stretch fabric  
 Product weight: 10 lb  
 Light source: integrated LED  
 Light output: 5000 Lumens (source)  
 Light color: 2700 K or 3500 K  
 Color accuracy: 90+ CRI  
 Power usage: 70 W  
 Dimmable (see driver below)  
 Brushed Aluminum (CM-006)  
 linear canopy included  
 Canopy dimensions: 20.6" x 4", 1.3"  
 Wood canopy covers are available:  
 Walnut (CM-001) cover:  
 part # 60-130-005W  
 Dark stained walnut (CM-002) cover:  
 part # 60-130-005D  
 See website for more canopy information  
 72" drop length, field adjustable  
 Suitable for a sloped ceiling  
 Wood grain will vary  
 Specifications subject to change  
 Patent pending



**MATERIAL & FINISH OPTIONS**

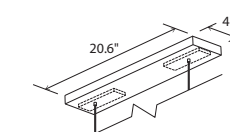
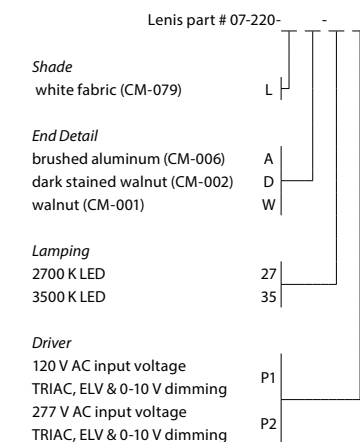

linear canopy,  
brushed aluminum



brushed aluminum  
(CM-006)



walnut  
(CM-001)



dark stained walnut  
(CM-002)

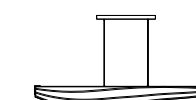

*Bret, Dan and I have always loved the ocean and boats. In fact, the first project we built together as young boys was a sailboat. Our appreciation for the beauty of a well-designed craft is what initially inspired the Lenis fixture; the form is created by bending wood stringers over a series of bulkheads. The organic and sculptural structure deviates from our mostly rectilinear forms, which introduced many new challenges, yet it also breathed new life into the design process for us. Ultimately, we were searching for that balance between the curved fluidity of its lines and the twisting movement. Thanks to our team's determination, after countless studies and prototypes, we found the balance we were looking for.*

Nick Sheridan,  
Designer



**Arca**  
linear pendant

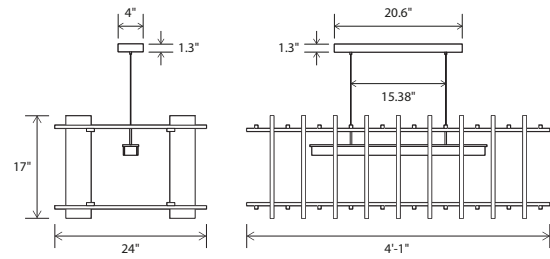

Dimensions: 4'-1" x 24", 17"  
 Materials: solid wood, aluminum, polymer  
 Product weight: 20 lb  
 Light source: integrated LED  
 Light output: 1720 Lumens (source)  
 Light color: 2700 K or 3500 K  
 Color accuracy: 90+ CRI  
 Power usage: 16 W  
 Dimmable (see driver below)  
 Linear canopy included  
 Canopy dimensions: 20.6" x 4", 1.3"  
 Canopy finish matches fixture's metal finish  
 Wood canopy covers are available:  
 Walnut (CM-001) cover: part # 60-130-005W  
 Dark stained walnut (CM-002) cover: part # 60-130-005D  
 See website for more canopy information  
 72" drop length, field adjustable  
 Suitable for a sloped ceiling  
 Wood grain will vary  
 Specifications subject to change

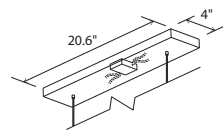

linear canopy, brushed aluminum



brushed aluminum (CM-006)



black anodized aluminum (CM-007)



walnut (CM-001)

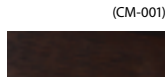

dark stained walnut (CM-002)

**MATERIAL & FINISH OPTIONS**

Arca part # 07-120-

**Metal Finish**  
 brushed aluminum (CM-006) A  
 black anodized aluminum (CM-007) B

**Wood Body**  
 walnut (CM-001) W  
 dark stained walnut (CM-002) D

**Lamping**  
 2700 K LED 27  
 3500 K LED 35

**Driver**  
 120-277 V AC input voltage  
 0-10V dimming P1  
 TRIAC and ELV dimming at 120 V AC only

**Includes**  
 polymer shade (CM-052)  
 frosted acrylic diffuser (CM-024)

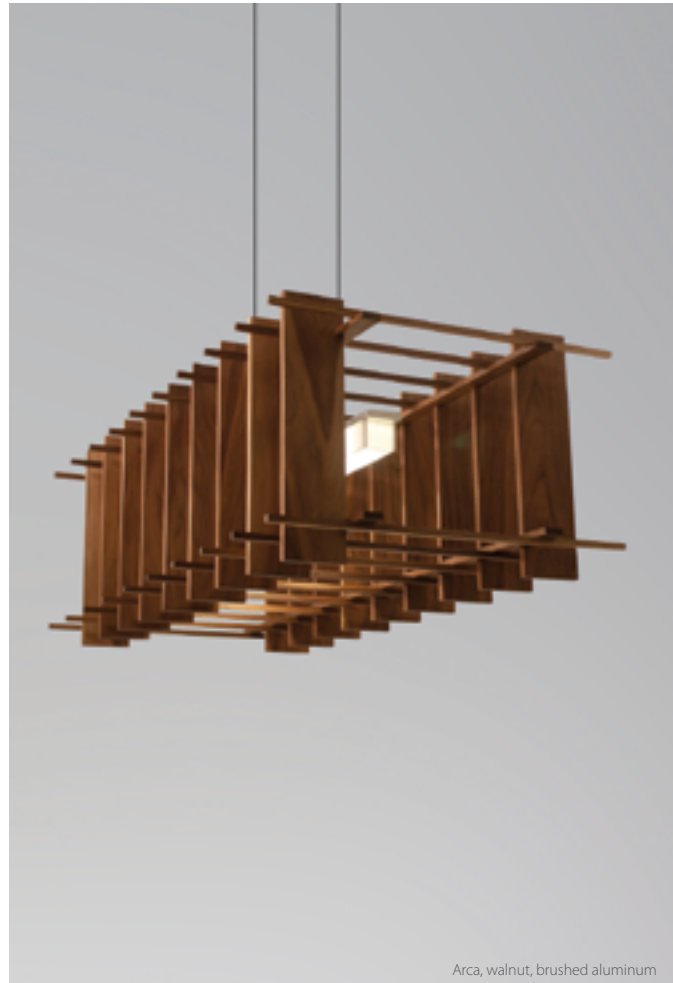

Arca, walnut, brushed aluminum



Arca, walnut, brushed aluminum

*The Arca is an experiment with density and mass. As one moves around the room, the fixture morphs from a commanding presence of solid walnut into a graceful bar of light surrounded by an elegant porous cage.*

Nick Sheridan  
 Designer

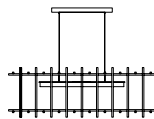
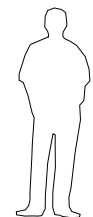

**Camur**  
linear pendant

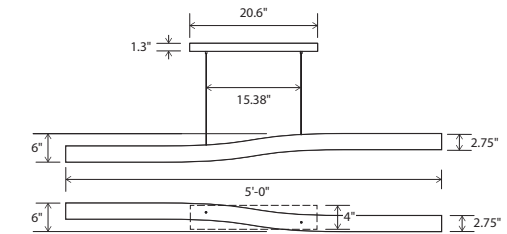

Dimensions: 5'-0" x 2.75", 2.75"  
 Materials: solid wood, polymer  
 Product weight: 6 lb  
 Light source: integrated LED  
 Light output: 2500 Lumens (source)  
 Light color: 2700 K or 3500 K  
 Color accuracy: 90+ CRI  
 Power usage: 35 W  
 Dimmable (see driver below)  
 Brushed aluminum (CM-006) camur canopy included  
 Canopy dimensions: 20.6" x 4", 1.3"  
 Wood camur canopy covers are available:  
 Walnut (CM-001) wood camur canopy cover: part # 60-150-005W  
 Dark stained walnut (CM-002) wood camur canopy cover: part # 60-150-005D  
 See website for more canopy information  
 72" drop length, field adjustable  
 Suitable for a sloped ceiling  
 Wood grain will vary  
 Specifications subject to change

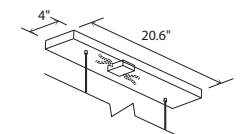

Camur canopy, brushed aluminum



Camur canopy cover, walnut



walnut (CM-001)

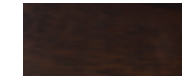

dark stained walnut (CM-002)

**MATERIAL & FINISH OPTIONS**

Camur part # 07-210-

**Wood Body**  
 walnut (CM-001) W  
 dark stained walnut (CM-002) D

**Lamping**  
 2700 K LED 27  
 3500 K LED 35

**Driver**  
 120 V AC input voltage  
 TRIAC, ELV & 0-10V dimming P1  
 277 V AC input voltage  
 TRIAC, ELV & 0-10V dimming P2

*The true beauty of the Camur is difficult to appreciate in print. When experiencing this fixture in person you begin to see the subtlety and grace of its vertical and horizontal movements. As you walk around this fixture the shape will morph from a beautiful curve to a straight line. We have created a video to help celebrate these details at [www.cernogroup.com/camur](http://www.cernogroup.com/camur)*

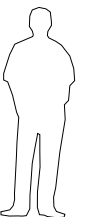
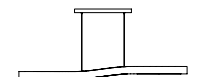

Camur, walnut



*Light and delicate, subtly unique while simple, the camur must be experienced to really be appreciated. The gentle curve appears from the bottom just the same as it does from the side: but the perspectives found between the two intrigue.*

Nick Sheridan,  
 Designer





in collaboration with  
**DESIRON FRANK CARFARO**  
 HAND CRAFTED AMERICAN FURNITURE



Aeris 54, walnut, brushed aluminum



Aeris 54, walnut, brushed aluminum

The Aeris was a collaboration with New York based designer Frank Carfaro of Desiron. The organic and often wild swirls of walnut grain are interrupted by rigorous slits and inlays that punctuate each face to create a beautiful juxtaposition, making each fixture unique. The glow of the illuminated wood seen through the cut slits creates a rich composition of light and shadow.

Nick Sheridan  
 Co-Designer

**Aeris 30 / Aeris 54**  
 linear pendant

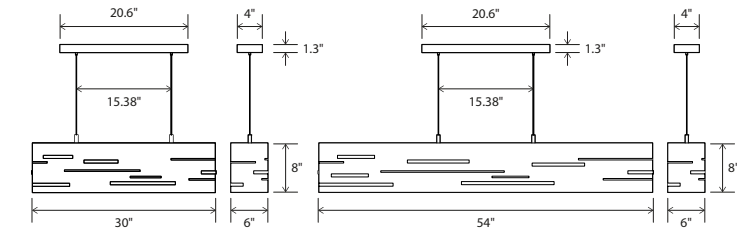

Aeris 30 dimensions: 30" x 6", 8"  
 Aeris 54 dimensions: 54" x 6", 8"  
 Materials: solid wood, aluminum  
 Aeris 30 weight: 11 lb  
 Aeris 54 weight: 15 lb  
 Light source: integrated LED  
 Light output - total: 1720 Lumens (source)  
 Light output - downlight: 1030 Lumens (source)  
 Light output - uplight: 690 Lumens (source)  
 Light color: 2700 K or 3500 K  
 Color accuracy: 90+ CRI  
 Power usage: 16 W  
 Dimmable (see driver below)  
 Linear canopy included  
 Canopy dimensions: 20.6" x 4", 1.3"  
 Canopy finish matches fixture's metal finish  
 Wood canopy covers are available:  
 Walnut (CM-001) cover: part # 60-130-005W  
 Dark stained walnut (CM-002) cover:  
 part # 60-130-005D  
 See website for more canopy information  
 72" drop length, field adjustable  
 Suitable for a sloped ceiling  
 Wood grain will vary  
 Specifications subject to change



**MATERIAL & FINISH OPTIONS**

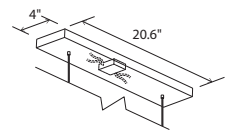
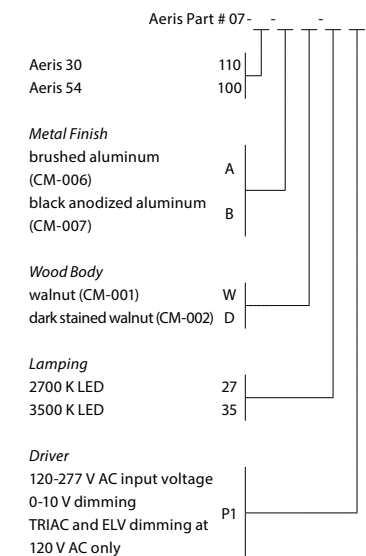

linear canopy,  
 brushed aluminum



brushed aluminum  
 (CM-006)



black anodized aluminum  
 (CM-007)

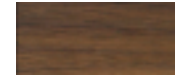

walnut  
 (CM-001)

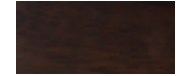

dark stained walnut  
 (CM-002)

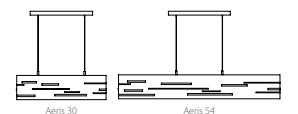

Aeris 30 Aeris 54





A clean, modern fixture finely executed. With multiple down and up lights, the Vix provides lots of usable light in a very unobtrusive design.

Nick Sheridan  
Designer

**Vix 34 / Vix 48**  
linear pendant

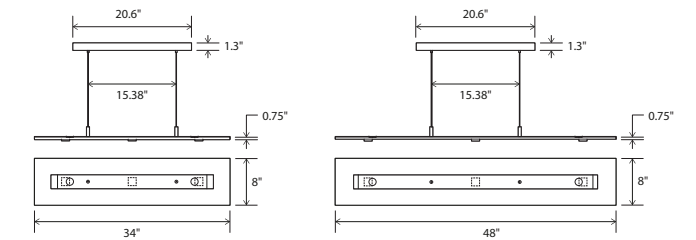

Vix 34 dimensions: 34" x 8", 0.75"  
 Vix 48 dimensions: 48" x 8", 0.75"  
 Materials: solid wood, polymer, aluminum  
 Vix 34 weight: 10 lb  
 Vix 48 weight: 15 lb  
 Light source: integrated LED  
 Light output - total: 1720 Lumens (source)  
 Light output - downlight: 1030 Lumens (source)  
 Light output - uplight: 690 Lumens (source)  
 Light color: 2700 K or 3500 K  
 Color accuracy: 90+ CRI  
 Power usage: 16 W  
 Dimmable (see driver below)  
 Brushed aluminum (CM-006) linear canopy included  
 Canopy dimensions: 20.6" x 4", 1.3"  
 Wood canopy cover available:  
 Walnut (CM-001) cover: part # 60-130-005W  
 Dark stained walnut (CM-002) cover:  
 part # 60-130-005D  
 See website for more canopy information  
 72" drop length, field adjustable  
 Suitable for a sloped ceiling  
 Wood grain will vary  
 Specifications subject to change

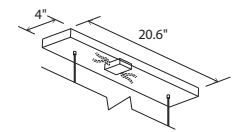

linear canopy,  
brushed aluminum



walnut  
(CM-001)



dark stained walnut  
(CM-002)

MATERIAL & FINISH OPTIONS

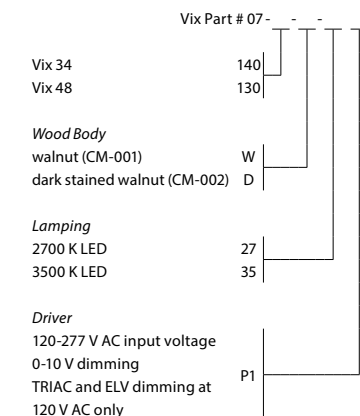

Vix 34  
Vix 48

Wood Body  
walnut (CM-001)  
dark stained walnut (CM-002)

Lamping  
2700 K LED  
3500 K LED

Driver  
120-277 V AC input voltage  
0-10 V dimming  
TRIAC and ELV dimming at  
120 V AC only

Includes  
polymer shade (CM-052)

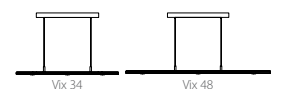





Vix 82, walnut



Vix 82, walnut

A clean, modern fixture finely executed. With multiple down and up lights, the Vix provides lots of usable light in a very unobtrusive design.

Nick Sheridan  
Designer

**Vix 82**  
linear pendant

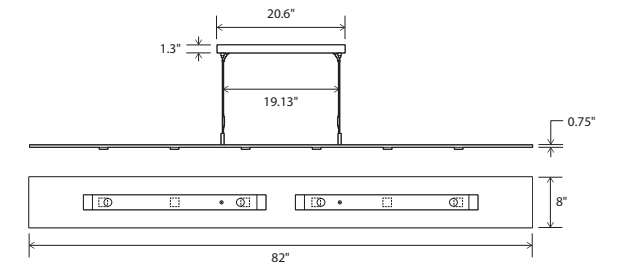

Dimensions: 82" x 8", 0.75"  
 Materials: solid wood, polymer, aluminum  
 Product weight: 19 lb  
 Light source: integrated LED  
 Light output - total: 3440 Lumens (source)  
 Light output - downlight: 2060 Lumens (source)  
 Light output - uplight: 1380 Lumens (source)  
 Light color: 2700 K or 3500 K  
 Color accuracy: 90+ CRI  
 Power usage: 32 W  
 Dimmable (see driver below)  
 Brushed aluminum (CM-006) linear canopy included  
 Canopy dimensions: 20.6" x 4", 1.3"  
 See website for more canopy information  
 Drop length field adjustable: 0'-10" min, 8'-0" max  
 Suitable for a sloped ceiling  
 Wood grain will vary  
 Wood shade may slightly bow or twist along 82" length  
 Specifications subject to change

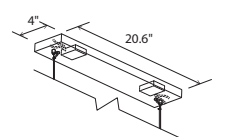

linear canopy, brushed aluminum

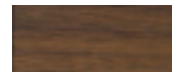

walnut (CM-001)



dark stained walnut (CM-002)

MATERIAL & FINISH OPTIONS

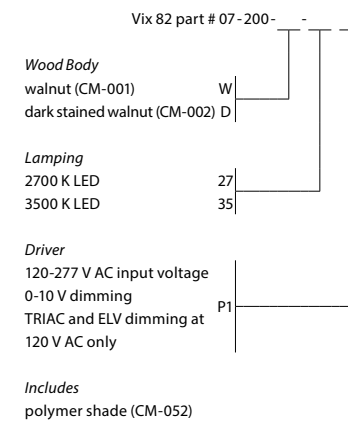



**Virga**  
linear pendant

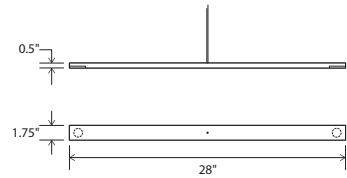

Dimensions: 28" x 1.75", 0.5"

Materials: aluminum, polymer

Product weight: 6 lb

Light source: integrated LED

Light output: 1126 Lumens (source)

Light color: 2700 K or 3500 K

Color accuracy: 90+ CRI

Power usage: 13 W

Dimmable (see driver below)

Extended-profile square canopy included, required to house LED driver (3.25" x 2.25" x 1.25")

Canopy dimensions: 4.5" x 4.5", 1.63"

Canopy finish matches fixture's metal finish

See website for more canopy information

48" suspension tube (can be shortened in field)

Swivel option available for sloped ceilings, see drawing below

Specifications subject to change

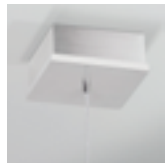
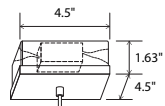

extended-profile square canopy  
brushed aluminum



brushed aluminum  
(CM-006)



black anodized aluminum  
(CM-007)

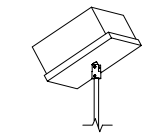

**MATERIAL & FINISH OPTIONS**

Virga part # 06-130-

**Metal Finish**

brushed aluminum (CM-006) A

black anodized aluminum (CM-007) B

**Lamping**

2700 K LED 27

3500 K LED 35

**Driver**

120-277 V AC input voltage

0-10V dimming

TRIAC and ELV dimming at

120 V AC only P1

**Includes**

polymer shade (CM-052)

Available for sloped ceilings:  
Sloped Extended-Profile Square Canopy



Virga, brushed aluminum



Virga, black anodized aluminum

A clean, minimal fixture executed without compromise. The very simple and sleek down light bar can be installed in very close proximity to its user – and withstand close scrutiny.

Nick Sheridan  
Designer

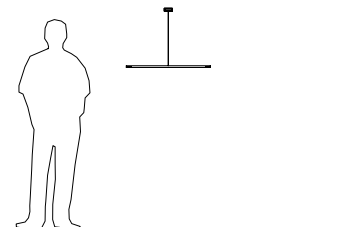

Brevis 28, brushed aluminum



Brevis 28, brushed aluminum

A clean, minimal fixture finely executed. With multiple down and up lights, the Brevis provides lots of usable light in a very unobtrusive design

Nick Sheridan  
Designer

**Brevis 28 / Brevis 42**  
linear pendants

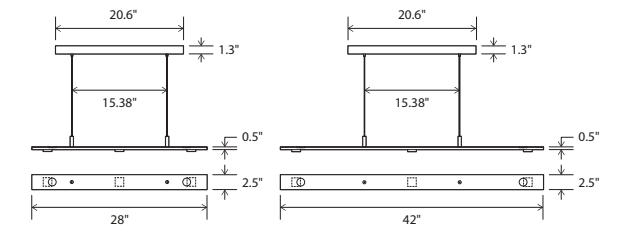

Brevis 28 dimensions: 28" x 2.5", 0.5"

Brevis 42 dimensions: 42" x 2.5", 0.5"

Materials: aluminum, polymer

Brevis 28 weight: 7 lb

Brevis 42 weight: 8 lb

Light source: integrated LED

Light output - total: 1720 Lumens (source)

Light output - downlight: 1030 Lumens (source)

Light output - uplight: 690 Lumens (source)

Light color: 2700 K or 3500 K

Color accuracy: 90+ CRI

Power usage: 16 W

Dimmable (see driver below)

Linear canopy included

Canopy dimensions: 20.6" x 4", 1.3"

Canopy finish matches fixture's metal finish

Wood canopy covers are available:

Walnut (CM-001) cover: part # 60-130-005W

Dark stained walnut (CM-002) cover: part # 60-130-005D

See website for more canopy information

72" drop length, field adjustable

Suitable for a sloped ceiling

Specifications subject to change

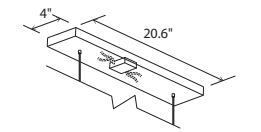

linear canopy,  
brushed aluminum



brushed aluminum  
(CM-006)



black anodized aluminum  
(CM-007)

**MATERIAL & FINISH OPTIONS**

Brevis Part # 06-

Brevis 28 920

Brevis 42 910

**Metal Finish**

brushed aluminum (CM-006) A

black anodized aluminum (CM-007) B

**Lamping**

2700 K LED 27

3500 K LED 35

**Driver**

120-277 V AC input voltage

0-10 V dimming

TRIAC and ELV dimming at

120 V AC only P1

**Includes**

polymer shade (CM-052)

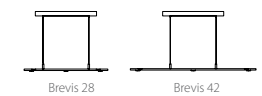

Brevis 28

Brevis 42







## Pendants



Muto



Muto



Abeo



Claudo



Imber



Ignis

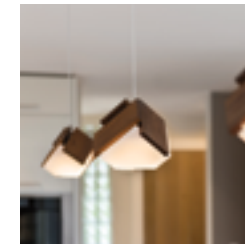

Mica



Mica Family



Ico

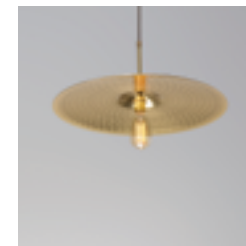

Ico



Levis Family



Salix



Calx 10/19



Calx 36

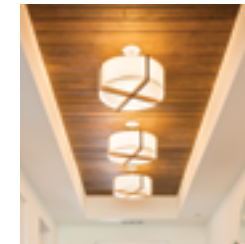

Plura Pendant



Plura Flush Mount



**Muto**  
large pendant

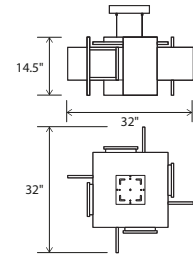

Dimensions: 32" x 32", 14.5"  
 Materials: solid wood, polymer  
 Product weight: 17 lb  
 Light source: integrated LED  
 Light output - total: 2626 Lumens (source)  
 Light output - ambient: 1376 Lumens (source)  
 Light output - downlight: 1250 Lumens (source)  
 Light color: 2700 K or 3500 K  
 Color accuracy: 90+ CRI  
 Power usage: 25 W  
 Dimmable (see driver below)  
 Brushed aluminum (CM-006) 8" square canopy with black mesh cables included  
 See instructions for additional canopy details at cernogroup.com  
 72" drop length, field adjustable  
 Suitable for a sloped ceiling  
 Wood grain will vary  
 Specifications subject to change

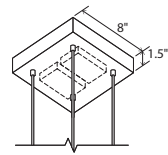

8" square canopy with black mesh cables

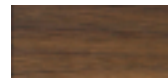

walnut (CM-001)

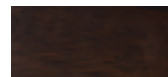

dark stained walnut (CM-002)

**MATERIAL & FINISH OPTIONS**

Muto part # 06-140-

**Wood Body**  
 walnut (CM-001)  
 dark stained walnut (CM-002)

**Lamping**

2700 K LED  
 3500 K LED

**Driver**

120-277 V AC input voltage  
 0-10 V dimming  
 TRIAC and ELV dimming at 120 V AC only

**Includes**

frosted polymer diffuser (CM-024)

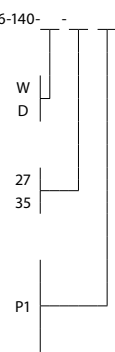

Muto, walnut



Muto, walnut

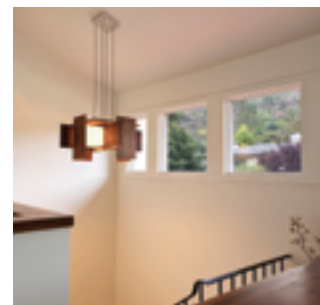

*The way the walnut planes in the Muto both block and bounce light makes for a very dynamic composition of light and shadow, from any vantage point. While the pinwheel form with its repeating elements is symmetric, it appears very sculptural from any one view. The modern floating ideal is realized in the Muto. By holding each walnut element away from its neighbor, so each plane floats, the whole fixture feels weightless as if it were floating itself.*

Nick Sheridan  
 Designer



Muto, walnut



**Imber 17 / Imber 24**  
pendant

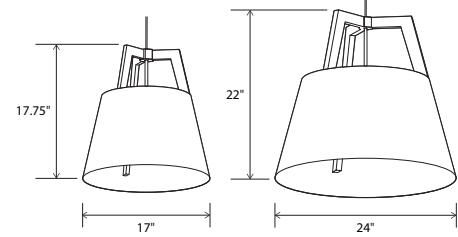

Imber 17 dimensions: 17" Ø, 17.75"  
Imber 24 dimensions: 24" Ø, 22"  
Materials: solid wood, metal  
Imber 17 weight: 7 lb  
Imber 24 weight: 12 lb  
Wood grain will vary  
Specifications subject to change

**Lamping**  
*Integrated LED Specifications*  
Light output: 1250 Lumens (source)  
Light color: 2700 K  
Additional color temperatures as well as sunset dimming are available upon request.  
Color accuracy: 90+ CRI  
Power usage: 13 W  
Input voltage: 120-277 V AC  
Dimmable: 0-10 V dimming at 120-277 V AC TRIAC and ELV dimming at 120 V AC only

**Medium Base E26 Specifications**  
Imber 17 lamping:  
1x E26 base, type A lamp, 75 W max  
Imber 24 lamping:  
3x E26 base, type A lamp, 75 W max each  
Bulbs not included  
Input voltage: 250 V AC max

**Suspension Type**  
*Corded*  
96" length of SVT wire is used. Wire is field adjustable and suitable for a sloped ceiling.  
*Rigid*  
Stem comes 6' long and is field cuttable to length (.038" Ø).

**Suspension and Hardware Finish**  
*Standard Combinations*  
Come with either black or satin nickel suspension, canopy, and sockets:  
Black: DW, DD, RW, GD  
Satin Nickel: AW, AM, WM  
*Corded Versions*  
White cord: satin nickel hardware  
Black cord: black hardware  
24" Imber corded uses a .06" Ø steel cable for suspension

**MATERIAL & FINISH OPTIONS**

Imber part # 06-210-	
<b>Fixture Size</b>	
17" Ø	17
24" Ø	24
<b>Standard Combinations (Shade, Frame)</b>	
distressed brass, walnut	DW
distressed brass, dark stained walnut	DD
brushed brass, walnut	RW
brushed aluminum, walnut	AW
brushed aluminum, maple	AM
brushed rose gold, dark stained walnut	GD
gloss white, maple	WM
<b>Suspension Type</b>	
corded	C
rigid	R
<b>Lamping</b>	
integrated LED with diffuser	L
medium base socket without diffuser	S
medium base socket with diffuser	D



**Diffuser**  
Frosted white diffuser (CM-024)  
Diffuser is recommended when fixture location may allow for direct glare.  
Integrated LED option always comes with a diffuser

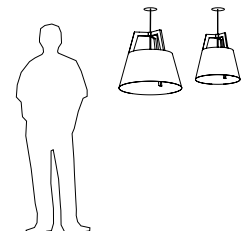

Imber 24, distressed brass, walnut

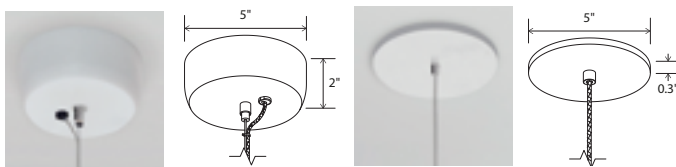

**Imber/Ignis 24 with LED lamping**  
Extended-profile round canopy, braided cord with steel cable included, required to house the LED driver (3.25" x 2.25" x 1.25")  
Canopy dimensions: 5.5"Ø, 2" deep

**Imber/Ignis 17 with LED lamping**  
Low-profile round canopy, braided cord included  
Canopy dimensions: 5"Ø, 0.3" deep



Ignis 24, brass, walnut

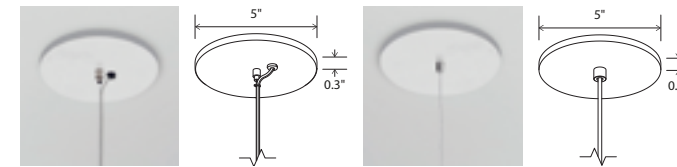

**Imber/Ignis 24 with Medium base socket**  
Low-profile round canopy, SPT with steel cable  
Canopy dimensions: 5"Ø, 0.3" deep

**Imber/Ignis 17 with Medium base socket**  
Low-profile round canopy, SVT included  
Canopy dimensions: 5"Ø, 0.3" deep

**Ignis 17 / Ignis 24**  
pendant

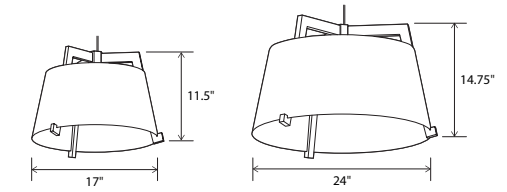

Ignis 17 dimensions: 17" Ø, 11.5"  
Ignis 24 dimensions: 24" Ø, 14.75"  
Materials: solid wood, metal  
Ignis 17 weight: 7 lb  
Ignis 24 weight: 11 lb  
Wood grain will vary  
Specifications subject to change

**Lamping**  
*Integrated LED Specifications*  
Light output: 1250 Lumens (source)  
Light color: 2700 K  
Additional color temperatures as well as sunset dimming are available upon request.  
Color accuracy: 90+ CRI  
Power usage: 13 W  
Input voltage: 120-277 V AC  
Dimmable: 0-10 V dimming at 120-277 V AC TRIAC and ELV dimming at 120 V AC only

**MATERIAL & FINISH OPTIONS**

Ignis part # 06-220-	
<b>Fixture Size</b>	
17" Ø	17
24" Ø	24
<b>Standard Combinations (Shade, Frame)</b>	
distressed brass, walnut	DW
distressed brass, dark stained walnut	DD
brushed brass, walnut	RW
brushed aluminum, walnut	AW
brushed aluminum, maple	AM
brushed rose gold, dark stained walnut	GD
gloss white, maple	WM
<b>Suspension Type</b>	
corded	C
rigid	R
<b>Lamping</b>	
integrated LED with diffuser	L
medium base socket without diffuser	S
medium base socket with diffuser	D

**Medium Base E26 Specifications**  
Ignis 17 lamping:  
1x E26 base, type A lamp, 75 W max  
Ignis 24 lamping:  
3x E26 base, type A lamp, 75 W max each  
Bulbs not included  
Input voltage: 250 V AC max

**Suspension Type**  
*Corded*  
8'-0" length of SVT wire is used. Wire is field adjustable and suitable for a sloped ceiling.  
*Rigid*  
Stem comes 6' long and is field cuttable to length (.038" Ø)

**Suspension and Hardware Finish**  
*Standard Combinations*  
Come with either black or satin nickel suspension, canopy, and sockets:  
Black: DW, DD, RW, GD  
Satin Nickel: AW, AM, WM  
*Corded Versions*  
White cord: satin nickel hardware  
Black cord: black hardware  
24" Ignis corded uses a 1/16" Ø steel cable for suspension

**Diffuser**  
Frosted white diffuser (CM-024)  
Diffuser is recommended when fixture location may allow for direct glare. Integrated LED option always comes with a diffuser (see previous page).

*The Ignis and Imber were inspired by the same design principles that make Cerno and ICRAVE well suited to collaborate. Honesty, simplicity, elemental, timeless and quality are words that sit at the core of both companies' design ethos and we believe these light fixtures embrace these qualities well. Each fixture was reduced to its essential parts – frame and shade – highlighting the interplay of the components, and accentuating the clean lines of the form.*

ICRAVE / Cerno

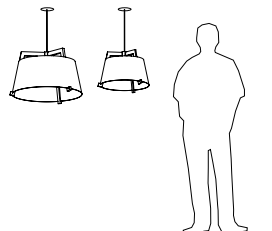





Ico pendant

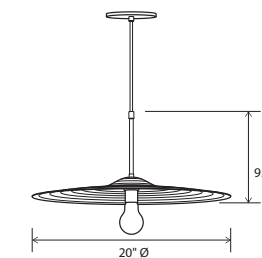

Dimensions: 20" Ø, 9.5"  
 Materials: solid brass  
 Product weight: 6 lb  
 Light source: medium base E26 socket  
 Lamping: 1x E26 base, 60 W max  
 Bulbs not included  
 Input voltage: 250 V AC max  
 Textured Black Powdercoat (CM-049)  
 low profile round canopy with Black Cloth Covered Cord (CM-090)  
 Canopy dimensions: 5" Ø, 0.3"  
 See website for more canopy information  
 Field adjustable drop length: 0'9" min - 8'0" max  
 Suitable for a sloped ceiling  
 Specifications subject to change

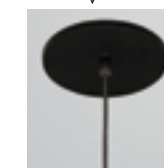
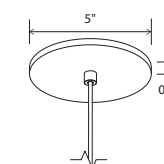

low-profile round canopy



MATERIAL & FINISH OPTIONS

	Ico part # 06-240-20	R - C
Fixture Size	20"	
Shade Finish	spun solid brass (CM-091)	R
Suspension	corded (CM-008)	C
Includes	brushed brass (CM-008)	

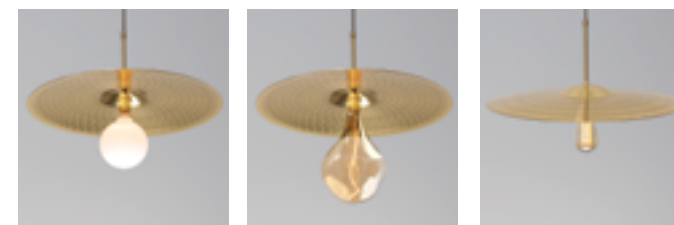

After working with drum cymbals on a few custom projects, we grew to appreciate the design and engineering that goes into these beautiful objects. Cymbals have a simple form, rich texture, and a beautiful brass finish. Modernism is often about utilizing what already exists and repurposing things, which is what we did with this fixture. The Ico looks excellent when paired with a simple light bulb.

Nick Sheridan  
 Designer





**Calx 10**  
accent pendant

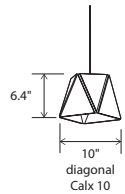

Dimensions: 6.75" x 6.75", 6.4"  
Materials: wood, metal, polymer  
Product weight: 2 lb  
Light source: integrated LED  
Light output: 345 Lumens (source)  
Light color: 2700 K or 3500 K  
Color accuracy: 90+ CRI  
Power usage: 3.2 W  
Dimmable (see driver below)  
White (CM-060) low-profile round canopy with white braided cord included  
Canopy dimensions: 5"Ø, 0.3"  
See website for more canopy information  
72" drop length, field adjustable  
Suitable for a sloped ceiling  
Wood grain will vary  
Specifications subject to change



**MATERIAL & FINISH OPTIONS**

Calx 10 part # 06-200-10

**Metal Finish**  
brushed aluminum (CM-012) A  
brushed rose gold (CM-046) G  
brushed brass (CM-047) R

**Wood Finish**  
walnut (CM-055) W  
dark stained walnut (CM-056) D

**Lamping**  
2700 K LED  
3500 K LED

**Driver**  
120VAC input voltage  
ELV dimming only

Calx sconce also available. See page 53

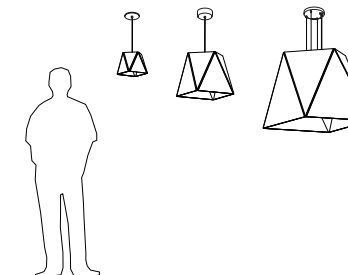

**MATERIAL & FINISH OPTIONS**

Calx 19 part # 06-200-19

**Metal Finish**  
brushed aluminum (CM-012) A  
brushed rose gold (CM-046) G  
brushed brass (CM-047) R

**Wood Finish**  
walnut (CM-055) W  
dark stained walnut (CM-056) D

**Lamping**  
2700 K LED  
3500 K LED  
medium base E26 socket

**Driver (LED version only)**  
120-277 V AC input voltage  
0-10 V dimming  
TRIAC and ELV dimming at 120 V AC only

**Includes**  
frosted polymer diffuser (CM-057)

**Calx 19**  
pendant

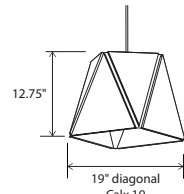

Dimensions: 13" x 13", 12.75"  
Materials: wood, metal, polymer  
Product weight: 7 lb  
Suitable for a sloped ceiling

**Integrated LED Specifications**  
Light output: 1250 Lumens (source)  
Light color: 2700 K or 3500 K  
Color accuracy: 90+ CRI  
Power usage: 13 W  
Dimmable (see driver below)

White (CM-060) extended-profile round canopy with white braided cord and steel cable included  
Canopy dimensions: 5"Ø, 2"  
Canopy required to house LED driver (3.3" x 1.6" x 1.0")  
See below for more canopy information  
72" drop length, field adjustable

**Medium Base Specifications**

Lamping: 1x E26 base, type A lamp, 60 W max  
Bulb not included  
Input voltage: 250 V AC max  
White (CM-060) low-profile round canopy with white SPT cord and steel cable included  
Canopy dimensions: 5"Ø, 0.3"  
72" drop length, field adjustable  
Suitable for a sloped ceiling  
Wood grain will vary  
Specifications subject to change

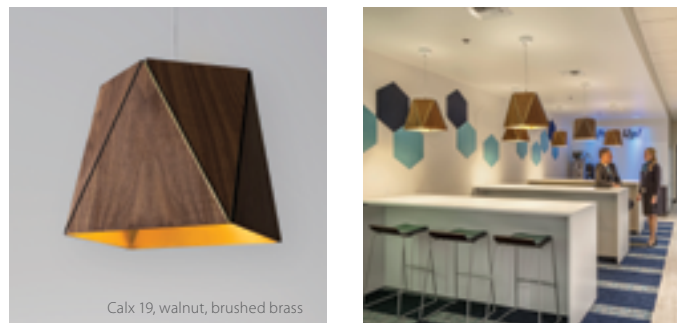

*The Calx is an example of modern design where the methods and the materials themselves are integral to its very conception, aligning form and function, which creates a synergy that is evident. The fixture ultimately forms a square aperture but enjoys a beautifully simple faceted structure.*

Nick Sheridan,  
Designer

**Calx 36**  
pendant

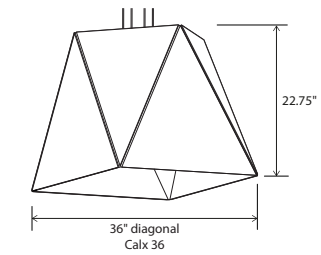

Dimensions: 25" x 25", 22.75"  
Materials: wood, metal, polymer  
Product weight: 18 lb  
Light source: 4x GU-24 base socket  
Lamping: 4x GU-24 base, 18 W max each  
Bulbs not included  
Input voltage: 300 V AC max  
White (CM-060) 8" round canopy included  
Canopy dimensions: 8"Ø, 1.25"  
See page left and website for more canopy information  
96" drop length, field adjustable  
Suitable for a sloped ceiling  
Wood grain will vary  
Specifications subject to change



**MATERIAL & FINISH OPTIONS**

Calx 36 part # 06-200-36

**Metal Finish**  
brushed aluminum (CM-012) A  
brushed rose gold (CM-046) G  
brushed brass (CM-047) R

**Wood Finish**  
walnut (CM-055) W  
dark stained walnut (CM-056) D

**Includes**  
frosted polymer diffuser (CM-057)

Calx sconce also available. See page 53.

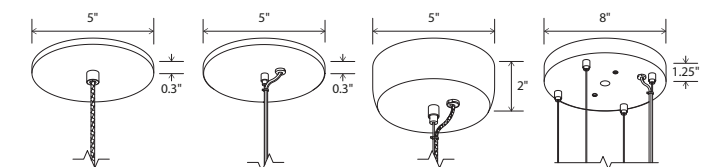
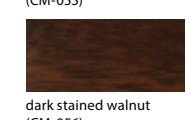
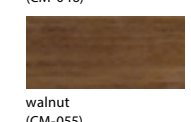
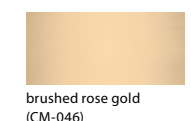

Calx 10 low-profile round canopy with braided cord  
Calx 19 E26 low-profile round canopy with white SPT with steel cable  
Calx 19 Integrated LED extended-profile round canopy with white braided cord with steel cable  
Calx 36 8" round canopy clear SPT with four 1/16" Ø steel cables



**Abeo**  
pendant

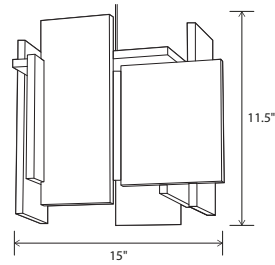

Dimensions: 15" Ø, 11.5"  
 Materials: solid wood, polymer  
 Product weight: 7 lb  
 Light source: integrated LED  
 Light output: 1250 Lumens (source)  
 Light color: 2700 K or 3500 K  
 Color accuracy: 90+ CRI  
 Power usage: 13 W  
 Dimmable (see driver below)  
 White (CM-060) extended-profile round canopy with white braided cord and steel cable included  
 Canopy dimensions: 5.5"Ø, 2"  
 Canopy required to house LED driver (3.3" x 1.6" x 1.0")  
 See website for more canopy information  
 72" drop length, field adjustable  
 Suitable for a sloped ceiling  
 Wood grain will vary  
 Specifications subject to change

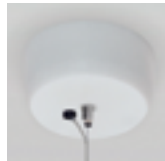
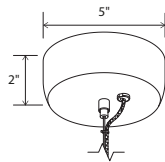

Extended-profile round canopy

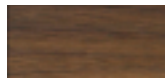

walnut (CM-001)



dark stained walnut (CM-002)

**MATERIAL & FINISH OPTIONS**

Abeo part # 06-190-	
Wood Body	W
walnut (CM-001)	D
dark stained walnut (CM-002)	
Lamping	27
2700 K LED	35
3500 K LED	
Driver	P1
120-277 V AC input voltage	
0-10 V dimming	
TRIAC and ELV dimming at 120 V AC only	
Includes	
frosted polymer (CM-024)	



Abeo, walnut

*I wanted to create a simple geometric sculpture that lets the light inside just sneak out around the floating walnut planes: letting the natural wood fall in and out of the light. It is this play with contrast and light and shadow that makes the Abeo such a dynamic piece.*

Nick Sheridan  
Designer

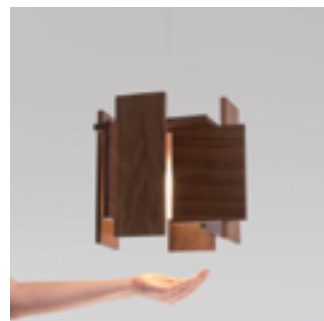

Clauo, walnut

*The Clauo showcases the beautiful natural walnut wood grain and sets it against the rigorous slits cut in each face as they wrap around the simple, clean shade form. A beautiful glow emanates from each slit, showing the striking rectilinear composition, in which all four sides are unique.*

Nick Sheridan  
Designer



**Clauo**  
accent pendant

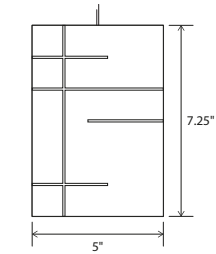

Dimensions: 5" x 5", 7.25"  
 Materials: solid wood, polymer  
 Product weight: 3 lb  
 Light source: integrated LED  
 Light output: 345 Lumens (source)  
 Light color: 2700 K or 3500 K  
 Color accuracy: 90+ CRI  
 Power usage: 3.2 W  
 Dimmable (see driver below)  
 Brushed aluminum (CM-006) low-profile square canopy with white braided cord included  
 Canopy dimensions: 4.5" x 4.5", 0.38"  
 Must use included external LED driver (2.25" x 1.5" x 1")  
 Accent pendants can be clustered by using multi-point round canopy or multi-point linear canopy  
 See website for more canopy information  
 72" drop length, field adjustable  
 Suitable for a sloped ceiling  
 Wood grain will vary  
 Specifications subject to change

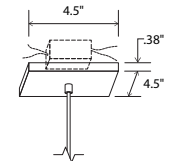

low-profile square canopy

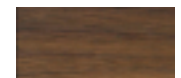

walnut (CM-001)

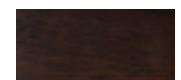

dark stained walnut (CM-002)

**MATERIAL & FINISH OPTIONS**

Clauo part # 06-110-	
Wood Body	W
walnut (CM-050)	D
dark stained walnut (CM-002)	
Lamping	27
2700 K LED	35
3500 K LED	
Driver	P1
120 V AC input voltage	
ELV dimming only	
Includes	
frosted polymer (CM-024)	

Also available in a sconce version

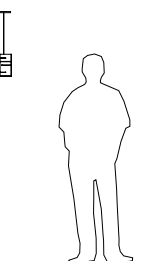
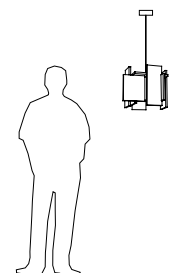





**Mica L**  
pendant

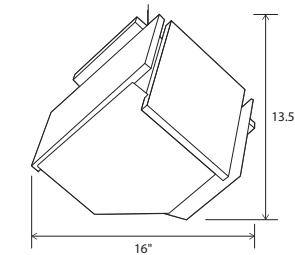

Dimensions: 16" Ø, 13.5"  
Materials: solid wood, polymer  
Product weight: 8 lb  
Suitable for a sloped ceiling

**Integrated LED Specifications**

Light output: 1250 Lumens (source)  
Light color: 2700 K or 3500 K  
Color accuracy: 90+ CRI  
Power usage: 13 W  
Dimmable (see driver below)  
Brushed aluminum (CM-006) extended-profile square canopy with white braided cord included  
Canopy dimensions: 4.5" x 4.5", 1.63"  
Canopy required to house LED driver (3.3" x 1.6" x 1.0")  
See website for more canopy information  
6'-0" drop length, field adjustable

**Medium Base Specifications**

Lamping: E26 base, type A lamp, 60 W max  
Bulb not included  
Input voltage: 250 V AC max  
White (CM-060) low-profile round canopy with clear SVT cord included  
Canopy dimensions: 5"Ø, 0.3"  
6'-0" drop length, field adjustable

Wood grain will vary  
Specifications subject to change



**MATERIAL & FINISH OPTIONS**

Mica L part # 06-180-

**Wood Body**  
walnut (CM-001) W  
dark stained walnut (CM-002) D

**Lamping**  
2700 K LED 27  
3500 K LED 35  
medium base E26 socket MB

**Driver (LED version only)**  
120-277 V AC input voltage  
0-10 V dimming  
TRIAC and ELV dimming at 120 V AC only P1

**Includes**  
frosted polymer (CM-024)

**Mica**  
accent pendant

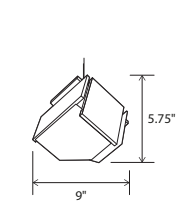

Dimensions: 9" Ø, 5.75"  
Materials: solid wood, polymer  
Product weight: 3 lb  
Light source: integrated LED  
Light output: 345 Lumens (source)  
Light color: 2700 K or 3500 K  
Color accuracy: 90+ CRI  
Power usage: 3.2 W  
Dimmable (see driver below)

**Brushed aluminum (CM-006) low-profile square canopy with white braided cord included**

Canopy dimensions: 4.5" x 4.5", 0.38"  
External LED driver (2.25" x 1.5" x 1")  
Accent pendants can be clustered by using multi-point round canopy or multi-point linear canopy  
See website for more canopy information  
6'-0" drop length, field adjustable  
Suitable for a sloped ceiling  
Wood grain will vary  
Specifications subject to change



**MATERIAL & FINISH OPTIONS**

Mica part # 06-160-

**Wood Body**  
walnut (CM-001) W  
dark stained walnut (CM-002) D

**Lamping**  
2700 K LED 27  
3500 K LED 35

**Driver**  
120 V AC input voltage  
ELV dimming only P1

**Includes**  
frosted polymer (CM-024)

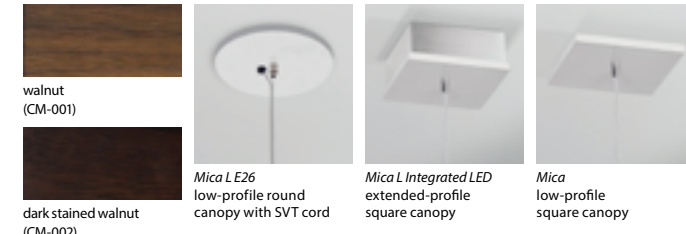
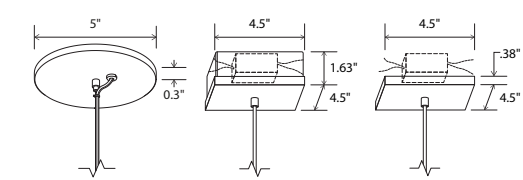
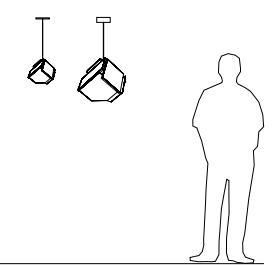

The Mica is simply a cube, which has been carefully deconstructed to a sculptural state. By way of the fixture's orientation and petal material composition, it exudes a certain organic symmetry. The Mica accent pendant acts as a beautiful node, creating a sense of space marked with an ambient glow.

Nick Sheridan  
Designer



**Levis**  
accent pendant

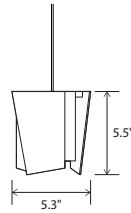

Dimensions: 5.3" Ø, 5.5" H  
 Materials: polymer, veneer and aluminum options  
 Product weight: 1 lb  
 Energy efficient LED light source  
 Light output: 345 Lumens (source)  
 Light color: 2700 K (warm) or 3500 K (cool)  
 Color accuracy: 90+ CRI  
 LED power consumption: 3.2W  
 Dimmable (see driver below)  
 Brushed aluminum (CM-006) Low-Profile Square Canopy included  
 Canopy dimensions: 4.5" x 4.5", 0.38"  
 Must use included external LED driver (2.25" x 1.5" x 1")  
 Accent pendants can be clustered by using Multi-Point Round Canopy or Multi-Point Linear Canopy  
 See website for more canopy information  
 6'-0" drop length, field adjustable  
 Suitable for a sloped ceiling  
 Wood grain will vary  
 Specifications subject to change



**MATERIAL & FINISH OPTIONS**

Levis accent part # 06-100-

<b>Shade</b>		
frosted polymer (CM-024)	F	
beech wood veneer (CM-019)	B	
brushed aluminum (CM-012)	A	
<b>Lamping</b>		
2700 K LED	27	
3500 K LED	35	
<b>Driver</b>		
120 V AC input voltage ELV dimming only	P1	

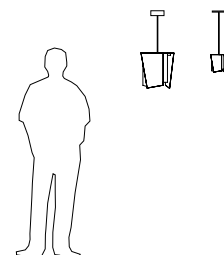

**Levis L**  
pendant

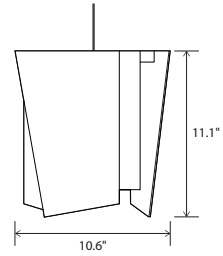

Dimensions: 10.6" Ø, 11.1"  
 Materials: polymer, veneer and aluminum options  
 Product weight: 7 lb  
 Suitable for a sloped ceiling

**Integrated LED Specifications**  
 Light output: 1250 Lumens (source)  
 Light color: 2700 K or 3500 K  
 Color accuracy: 90+ CRI  
 Power usage: 13 W  
 Dimmable (see driver below)

Brushed aluminum (CM-006) extended-profile square canopy with white braided cord included  
 Canopy dimensions: 4.5" x 4.5", 1.63"  
 Canopy required to house LED driver (3.3" x 1.6" x 1.0")  
 See website for more canopy information  
 6'-0" drop length, field adjustable

**Medium Base Specifications**

Lamping: E26 base, type A lamp, 60 W max  
 Input voltage: 250 V AC Max  
 White (CM-060) low-profile round canopy with clear SVT cord included  
 Canopy dimensions: 5"Ø, 0.3"  
 6'-0" drop length, field adjustable

**Specifications subject to change**

**MATERIAL & FINISH OPTIONS**

Levis L part # 06-170-

<b>Shade</b>		
frosted polymer (CM-024)	F	
beech wood veneer (CM-019)	B	
brushed aluminum (CM-012)	A	
<b>Lamping</b>		
2700 K LED	27	
3500 K LED	35	
<b>Driver</b>		
120-277 V AC input voltage 0-10 V dimming TRIAC and ELV dimming at 120 V AC only	P1	



Levis L, frosted polymer

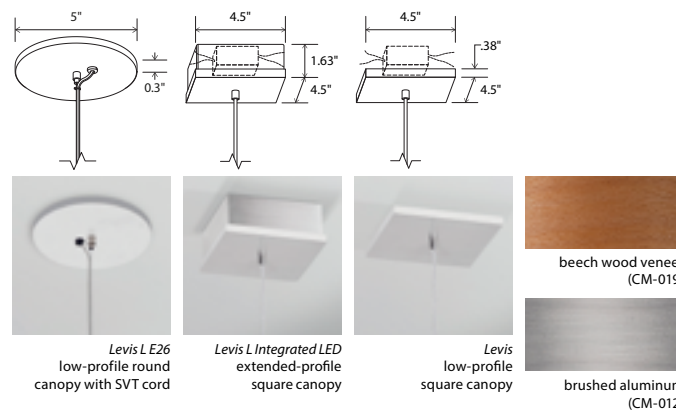

The Levis is simple and clean at first glance: complex upon closer review. The rhythm in the facets gives a dynamic feel from different vantage points, creating a sophistication to its presence.

Nick Sheridan  
Designer

**Salix**  
accent pendant

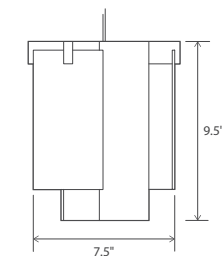

Dimensions: 7.5" x 7.5", 9.0"  
 Materials: solid wood, polymer, aluminum  
 Product weight: 3 lb  
 Light source: integrated LED  
 Light output: 345 Lumens (source)  
 Light color: 2700 K or 3500 K  
 Color accuracy: 90+ CRI  
 Power usage: 3.2 W  
 Dimmable (see driver below)  
 Brushed aluminum (CM-006) low-profile square canopy with white braided cord included  
 Canopy dimensions: 4.5" x 4.5", 0.38"  
 Must use included external LED driver (2.25" x 1.5" x 1")  
 Accent pendants can be clustered by using multi-point round canopy or multi-point linear canopy  
 See website for more canopy information  
 6'-0" drop length, field adjustable  
 Suitable for a sloped ceiling  
 Wood grain will vary  
 Specifications subject to change

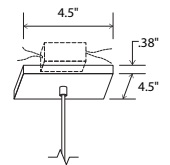

low-profile square canopy



**MATERIAL & FINISH OPTIONS**

Salix part # 06-120-W A -

<b>Wood Body</b>		
walnut (CM-001)	W	
<b>Metal Finish</b>		
brushed aluminum (CM-012)	A	
<b>Lamping</b>		
2700 K LED	27	
3500 K LED	35	
<b>Driver</b>		
120VAC input voltage ELV dimming only	P1	

**Includes**  
frosted polymer (CM-024)



Salix, brushed aluminum

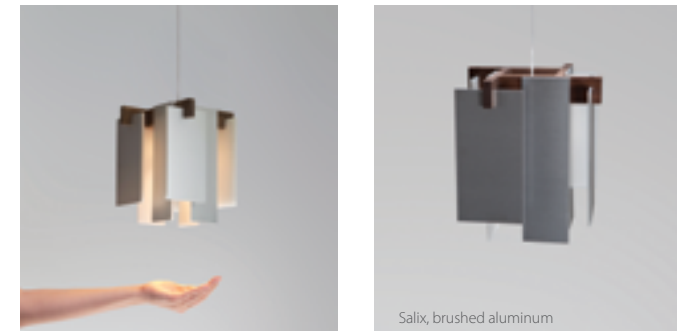

The Salix pendant's materials and proportions are in perfect harmony. The brushed aluminum set against the oiled walnut in this fixture still feels strikingly fresh and beautiful after years of production.

Nick Sheridan  
Designer

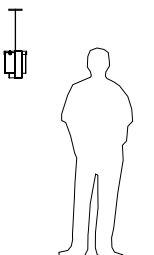





The Plura is a simple, straight forward fixture that is excellently executed. With the Plura it was about resolving the seams and edges and their relationships to one another. The result is a scalable fixture that has a sharp, sophisticated feel.

Nick Sheridan  
Designer

BOBBY BERK INTERIORS AND DESIGN



Plura 36 Pendant, walnut

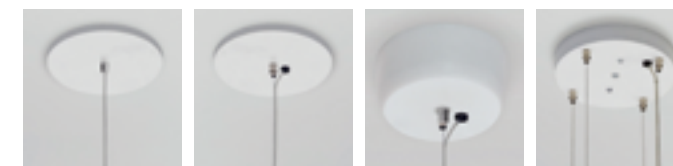
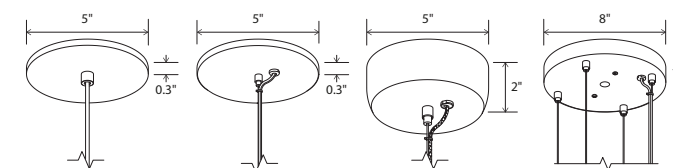

Plura 18 and Plura 24 low-profile round canopy with white SVT  
 Plura 30 GU-24 Base Sockets low-profile round canopy clear SPT with steel cable  
 Plura 30 Integrated LED extended round canopy, clear SPT with steel cable  
 Plura 36 8" round canopy clear SPT with four 1/16" Ø steel cables



Plura pendant

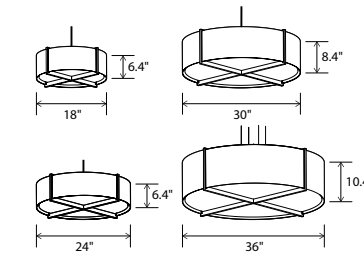

Dimensions:  
 Plura 18: 18" Ø, 6.4"  
 Plura 24: 24" Ø, 6.4"  
 Plura 30: 30" Ø, 8.4"  
 Plura 36: 36" Ø, 10.4"  
 Materials: solid wood, polymer  
 Product weight:  
 Plura 18: 5 lb  
 Plura 24: 6 lb  
 Plura 30: 9 lb  
 Plura 36: 13 lb

Integrated LED Specifications  
 Light output:  
 Plura 18 & 24: 1690 Lumens (source)  
 Plura 30 & 36: 2815 Lumens (source)  
 Light color: 2700 K or 3500 K  
 Color accuracy: 90+ CRI  
 Power usage:  
 Plura 18 & 24: 19.5 W  
 Plura 30 & 36: 32.5 W  
 Dimmable (see driver below)

GU-24 Base Specifications  
 Light source:  
 Plura 18 & 24: 2x GU-24 base socket  
 Plura 30 & 36: 4x GU-24 base socket  
 Lamping:  
 Plura 18 & 24: 2x GU-24 base, 18 W max each  
 Plura 30 & 36: 4x GU-24 base, 18 W max each  
 Bulbs not included  
 Input voltage: 300 V AC max

96" drop length, field adjustable  
 Suitable for a sloped ceiling  
 Wood grain will vary  
 Specifications subject to change



MATERIAL & FINISH OPTIONS

Plura pendant part # 06-230-

Ø:	
18" Ø	18
24" Ø	24
30" Ø	30
36" Ø	36

<b>Wood Body</b>	
walnut (CM-001)	W
dark stained walnut (CM-002)	D
white washed oak (CM-095)	O

<b>Shade Material</b>	
frosted polymer (CM-051)	F
matte black (CM-085)	B
with matte white interior	
brushed aluminum (CM-012)	A
brushed rose gold (CM-046)	R
brushed brass (CM-047)	G
distressed brass (CM-096)	D
gloss white (CM-054)	W

<b>Lamping</b>	
2700 K LED	27
3500 K LED	35
GU-24 base sockets	GU

<b>Driver (LED version only)</b>	
120-277 V AC input voltage	
0-10 V dimming	
TRIAC and ELV dimming at 120 V AC only	P1

Includes  
 frosted polymer (CM-051)

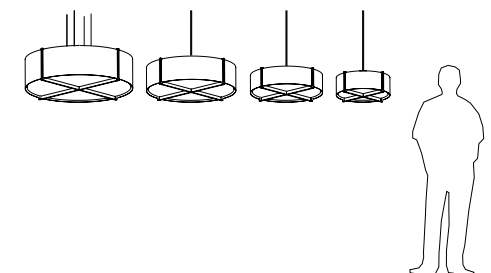





Plura 36 flush mount, walnut

**Plura**  
flush mount

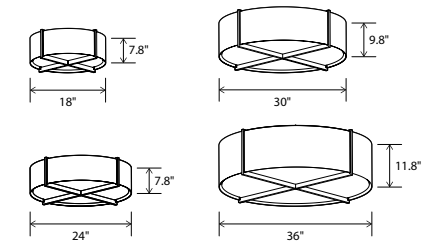

**Dimensions:**  
 Plura 18: 18" Ø, 7.8"  
 Plura 24: 24" Ø, 7.8"  
 Plura 30: 30" Ø, 9.8"  
 Plura 36: 36" Ø, 11.8"  
**Materials:** solid wood, metal, polymer  
**Product weight:**  
 Plura 18: 5 lb  
 Plura 24: 6 lb  
 Plura 30: 9 lb  
 Plura 36: 13 lb

**Integrated LED Specifications**  
**Light output:**  
 Plura 18 & 24: 1690 Lumens (source)  
 Plura 30 & 36: 2815 Lumens (source)  
**Light color:** 2700 K or 3500 K  
**Color accuracy:** 90+ CRI  
**Power usage:**  
 Plura 18 & 24: 19.5 W  
 Plura 30 & 36: 32.5 W  
 Dimmable (see driver below)

**GU-24 Base Specifications**  
**Light source:**  
 Plura 18 & 24: 2x GU-24 base socket  
 Plura 30 & 36: 4x GU-24 base socket  
**Lamping:**  
 Plura 18 & 24: 2x GU-24 base, 18 W max each  
 Plura 30 & 36: 4x GU-24 base, 18 W max each  
 Bulbs not included  
 Input voltage: 300 V AC max

Suitable for a sloped ceiling  
 Wood grain will vary  
 Specifications subject to change



Emergency backup option available upon request  
 Also available in a pendant version

**MATERIAL & FINISH OPTIONS**

Plura flush mount part # 08-100-

Ø:		
18" Ø	18	
24" Ø	24	
30" Ø	30	
36" Ø	36	

<b>Wood Body</b>		
walnut (CM-001)	W	
dark stained walnut (CM-002)	D	
white washed oak (CM-095)	O	

<b>Shade Material</b>		
frosted polymer (CM-051)	F	
matte black (CM-085)	B	
with matte white interior		
brushed aluminum (CM-012)	A	
brushed rose gold (CM-046)	R	
brushed brass (CM-047)	G	
distressed brass (CM-096)	D	
gloss white (CM-054)	W	

<b>Lamping</b>		
2700 K LED	27	
3500 K LED	35	
GU-24 base sockets	GU	

<b>Driver (LED version only)</b>		
120-277 V AC input voltage		
0-10 V dimming		
TRIAC and ELV dimming at 120 V AC only	P1	

**Includes**  
 frosted polymer (CM-051)

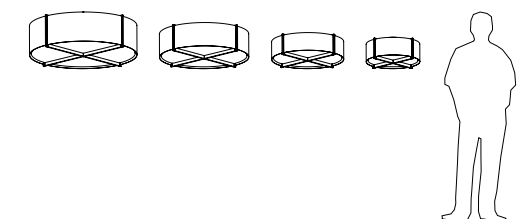



### Sconces

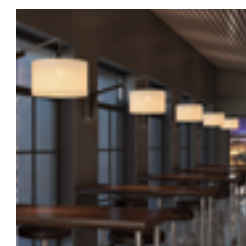

Talea



Talea



Tersus



Sedo



Via



Calx Sconce



Ansa



Ansa

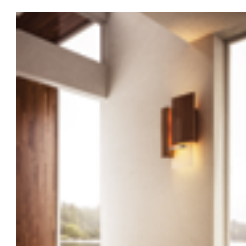

Vesper

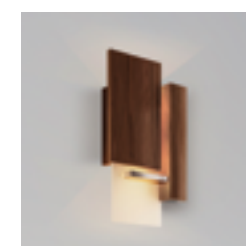

Vesper



Fortis



Claudo Sconce



Acuo

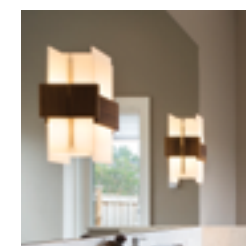

Acuo



Cubo



Libri



Capiro family

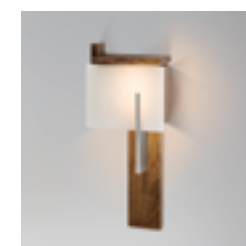

Oris

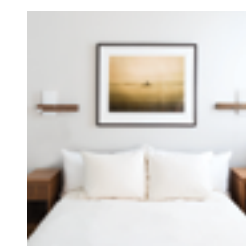

Levo



Levo







Talea, burlap shade, walnut body, textured black powdercoat

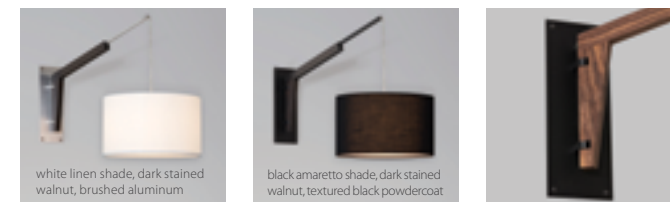

white linen shade, dark stained walnut, brushed aluminum

black amaretto shade, dark stained walnut, textured black powdercoat

The adaptive and interactive features of the Talea introduced exciting challenges to the design process. I believe we found a balance that allows this fixture to thrive in a range of spaces and different applications. I am really pleased with how the design language turned out, specifically how the expressive hinge suggests its ability to swing, and how the wood to metal arm detailing suggests the arm can telescope. It's a beautiful mixture of utility and elegance.

Nick Sheridan  
Designer

Talea, white linen shade, dark stained walnut body, brushed aluminum,

**Talea**  
articulate wall sconce

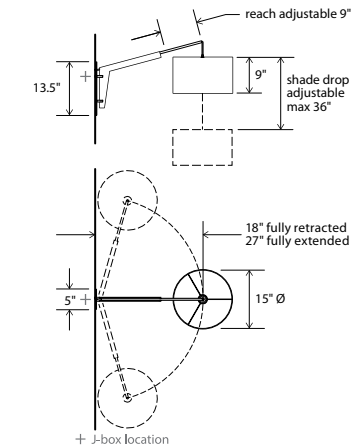

Dimensions: 18.38" x 5" x 34.75", 15" Ø shade  
Materials: solid wood, metal  
Product weight: 5 lb  
Light source: medium base E26 socket  
Lamping: E26 base, type A lamp, 60 W max  
Bulb not included  
Input voltage: 250 V AC max  
Clear SVT-3 cord included  
Top and bottom diffusers included (CM-051)  
Wood grain will vary  
Specifications subject to change  
Patent pending



**SWING ARM LENGTH**  
Arm length (from the wall to center of shade) can be adjusted between 18" and 27"

**DROP LENGTH**  
Max drop length from tip of extended arm to top of shade is 36"

**SWING ARM ROTATION**  
Adjustable resistance in pivot hinge

**MATERIAL & FINISH OPTIONS**

Talea part # 03-210-

**Metal Finish**  
brushed aluminum (CM-006) A  
textured black powdercoat (CM-049) B

**Wood Body**  
walnut (CM-001) W  
dark stained walnut (CM-002) D

**Fabric Shade**  
burlap (CM-017) N  
white linen (CM-016) L  
black amaretto (CM-018) A

**Includes**  
frosted polymer diffuser (CM-051)

For additional products that utilize the swing arm bracket, please see our Motus Swing Arm Bracket on page 78



brushed aluminum (CM-006)



textured black (CM-049)

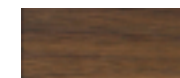

walnut (CM-001)



dark stained walnut (CM-002)



burlap (CM-017)



white linen (CM-016)



black amaretto (CM-018)

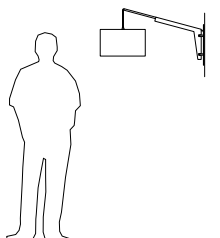



**Via**  
sconce or ceiling flush mount

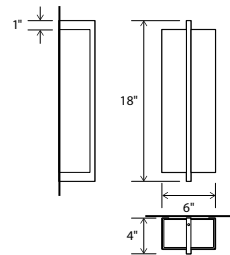

Dimensions: 18" x 6" x 4"  
Materials: solid wood, polymer  
Product weight: 2 lb

**Integral LED Specifications**  
Light output: 500 Lumens (source)  
Light color: 2700 K or 3500 K  
Color accuracy: 90+ CRI  
Power usage: 7 W  
Driver location: must be housed in J-box  
Driver dimensions: 3" x 1.5" x 1", included  
Mounting: ceiling or wall

**Candelabra Base Specifications**  
Lamping: 2x candelabra E12 base sockets,  
10 W max each (bulbs not included)  
Select bulbs can achieve over 500 lumens each  
Input voltage: 120 V AC max  
Mounting: wall only



**MATERIAL & FINISH OPTIONS**

Via part # 03-190-	
<b>Wood Body</b>	
walnut (CM-001)	W
dark stained walnut (CM-002)	D
<b>Lamping</b>	
2700 K LED	27
3500 K LED	35
Candelabra E12 socket	CB
<b>Driver (LED version only)</b>	
120 V AC input voltage	P1
TRIAC, ELV & 0-10V dimming	
277 V AC input voltage	P2
TRIAC, ELV & 0-10V dimming	

**Includes**  
frosted polymer (CM-051)

**Inquire about other input voltages**  
Emergency backup option available upon request



walnut (CM-001)

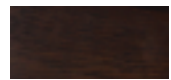

dark stained walnut (CM-002)



Via, walnut, candelabra E12 socket

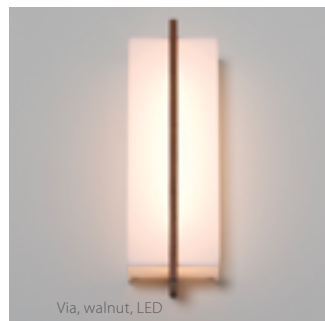

Via, walnut, LED

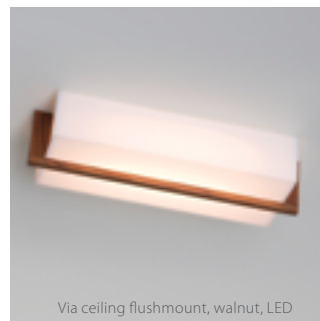

Via ceiling flushmount, walnut, LED

*The Via has an understated geometry with sophisticated detailing and proportion. The substantial glowing volume of the Via is punctuated by a thin plane of rich American walnut striking a balance and harmony.*

Nick Sheridan  
Designer

**Calx**  
sconce

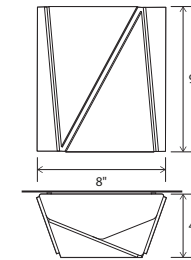

Dimensions: 8" x 9" x 4"  
Materials: wood, metal  
Product weight: 2 lb  
Light source: integrated LED  
Light output: 1130 Lumens (source)  
Light color: 2700 K or 3500 K  
Color accuracy: 90+ CRI  
Power usage: 13 W  
Dimmable (see driver below)  
Wood grain will vary  
Specifications subject to change



**MATERIAL & FINISH OPTIONS**

Calx sconce part # 03-138-

<b>Metal Finish</b>	
brushed aluminum (CM-012)	A
brushed rose gold (CM-046)	G
brushed brass (CM-047)	R
<b>Wood Finish</b>	
walnut (CM-055)	W
dark stained walnut (CM-056)	D

<b>Lamping</b>	
2700 K LED	27
3500 K LED	35

<b>Driver</b>	
120-277 V AC input voltage	
0-10 V dimming	
TRIAC and ELV dimming at 120 V AC only	P1

Calx pendants also available see pages 38, 39



brushed aluminum (CM-012)



brushed rose gold (CM-046)



brushed brass (CM-047)



walnut (CM-055)



dark stained walnut (CM-056)



Calx, walnut, brushed brass

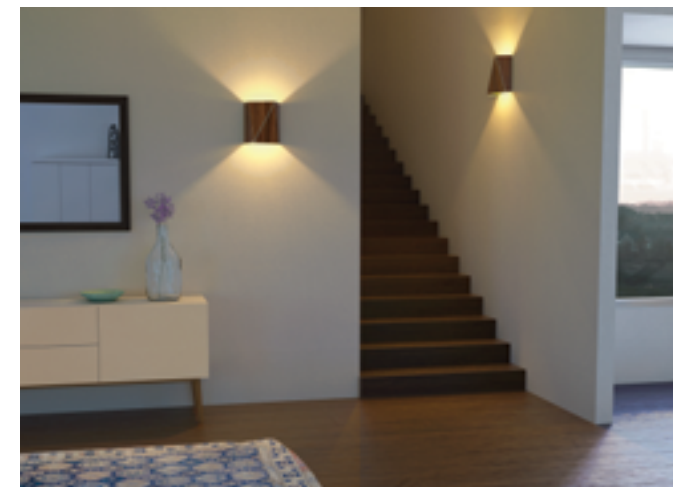

*Inspired by the Calx pendant, the materials and method inform the design greatly. While the Calx sconce is clean and simple, it also offers a beautiful texture and subtle complexity to a wall.*

Nick Sheridan  
Designer

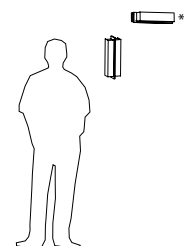

\* LED version only

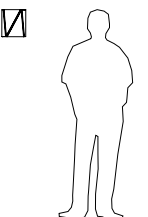





**Vesper**  
sconce

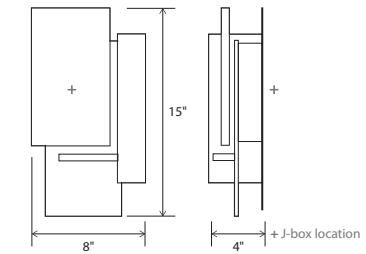

Dimensions: 15" x 8" x 4"  
 Materials: solid wood, polymer, aluminum  
 Product weight: 4 lbs  
 Light source: integrated LED  
 Light output: 1130 Lumens (source)  
 Light color: 2700 K or 3500 K  
 Color accuracy: 90+ CRI  
 LED power consumption: 13W  
 Dimmable (see driver below)  
 ADA compliant hotel room signage with tactile numbering and corresponding braille available  
 Wood grain will vary  
 Specifications subject to change



walnut (CM-001)

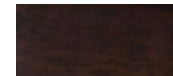

dark stained walnut (CM-002)



MATERIAL & FINISH OPTIONS

Vesper part # 03-132-		-
<b>Wood Body</b>		
walnut (CM-001)	W	
dark stained walnut (CM-002)	D	
<b>Lamping</b>		
2700 K LED	27	
3500 K LED	35	
<b>Driver</b>		
120-277 V AC input voltage		
0-10V dimming		
TRIAC and ELV dimming at 120 V AC only	P1	

**Includes**  
 frosted polymer (CM-024)  
 brushed aluminum (CM-006)



Vesper, walnut

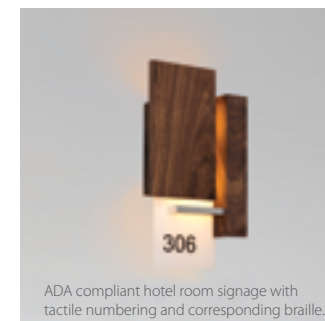

ADA compliant hotel room signage with tactile numbering and corresponding braille.

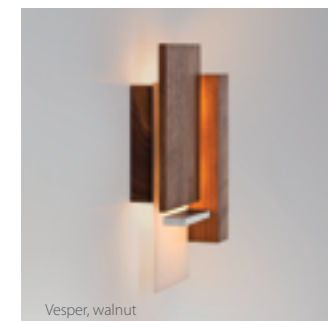

Vesper, walnut

The Vesper is a very simple geometric sculpture composed of brushed aluminum, American black walnut, and white polymer. The light not only washes up and down the wall but also filters out through the composition, exhibiting the fixture's depth in three dimensions.

Nick Sheridan  
 Designer

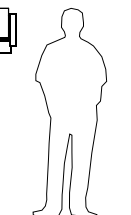



Acuo  
sconce

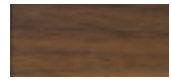
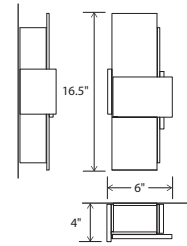

walnut  
(CM-001)

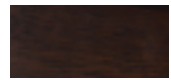

dark stained walnut  
(CM-002)



brushed aluminum  
(CM-006)

Dimensions: 16.5" x 6" x 4"  
 Materials: solid wood, polymer, aluminum  
 Product weight:  
 3 lb (CM-001/CM-002)  
 5 lb (CM-006)  
**Integrated LED Specifications**  
 Light output: 1130 Lumens (source)  
 Light color: 2700 K or 3500 K  
 Color accuracy: 90+ CRI  
 Power usage: 13 W  
 Dimmable (see driver below)

**GU-24 Base Specifications**  
 Lamping: 2x GU-24 base sockets, 18 W max each  
 Input voltage: 300 V AC max

ADA compliant hotel room signage with tactile numbering and corresponding braille available

Wood grain will vary  
 Specifications subject to change



MATERIAL & FINISH OPTIONS

Acuo part # 03-130-

Body

- walnut (CM-001) W
- dark stained walnut (CM-002) D
- brushed aluminum (CM-006) A

Lamping

- 2700 K LED 27
- 3500 K LED 35
- GU-24 base sockets GU

Driver (LED version only)

- 120-277 V AC input voltage
- 0-10 V dimming
- TRIAC and ELV dimming at 120 V AC only P1

Includes

- frosted polymer (CM-024)

J-box centered behind wood/aluminum body



Acuo, walnut



Acuo, walnut



Acuo, brushed aluminum

*It's a 3 sided box, which has been carefully deconstructed to a sculptural state. The careful composition of overlap and void create interest and complexity to a very straightforward, well-functioning wall sconce. The tectonic disconnection in form allows you to witness the solid American black walnut's grain as it travels through each solid block.*

Nick Sheridan  
Designer

Emergency backup option available upon request, requires oversized J-box.



Acuo, walnut



**Capio S**  
sconce

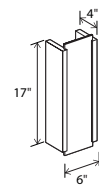

Dimensions: 17" x 6" x 4"  
 Materials: solid wood, polymer  
 Product weight: 4 lb  
 Light source: integrated LED  
 Light output: 500 Lumens (source)  
 Light color: 2700 K or 3500 K  
 Color accuracy: 90+ CRI  
 Power usage: 7 W  
 Dimmable (see driver below)  
 ADA compliant hotel room signage with tactile numbering and corresponding braille available  
 Wood grain will vary  
 Specifications subject to change



**Capio L**  
sconce

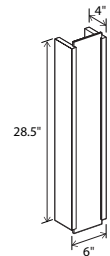

Dimensions: 28.5" x 6" x 4"  
 Materials: solid wood, polymer  
 Product weight: 7 lb  
 Light source: integrated LED  
 Light output: 1000 Lumens (source)  
 Light color: 2700 K or 3500 K  
 Color accuracy: 90+ CRI  
 Power usage: 14 W  
 Dimmable (see driver below)  
 ADA compliant hotel room signage with tactile numbering and corresponding braille available  
 Wood grain will vary  
 Specifications subject to change



MATERIAL & FINISH OPTIONS

Capio S part # 03-180-S

<b>Wood Body</b>	W	
walnut (CM-001)	D	
dark stained walnut (CM-002)	M	
maple (CM-005)		
<b>Lamping</b>		
2700 K LED	27	
3500 K LED	35	
<b>Driver</b>		
120 V AC input voltage	P1	
TRIAC, ELV & 0-10 V dimming		
277 V AC input voltage	P2	
TRIAC, ELV & 0-10 V dimming		
<b>Includes</b>		
frosted polymer (CM-024)		

MATERIAL & FINISH OPTIONS

Capio L part # 03-180-L

<b>Wood Body</b>	W	
walnut (CM-001)	D	
dark stained walnut (CM-002)	M	
maple (CM-005)		
<b>Lamping</b>		
2700 K LED	27	
3500 K LED	35	
<b>Driver</b>		
120 V AC input voltage	P1	
TRIAC, ELV & 0-10 V dimming		
277 V AC input voltage	P2	
TRIAC, ELV & 0-10 V dimming		
<b>Includes</b>		
frosted polymer (CM-024)		

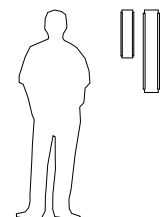

Capio S, Capio L, walnut



dark stained walnut (CM-002)



walnut (CM-001)



maple (CM-005)



Capio L, maple Capio L, walnut

The Capio is an exercise in restraint and efficiency consisting of just two solid wood sides that capture a single light diffusing lens. The clean and simple design allows for horizontal or vertical mounting as well as compelling compositions when used in multiples.

Nick Sheridan  
Designer

Emergency backup option available upon request, requires oversized J-box.



Oris, walnut

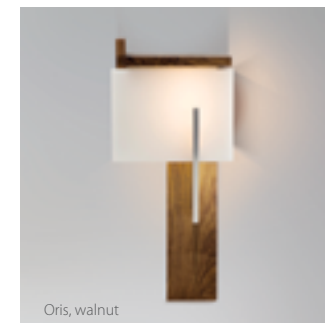

Oris, walnut

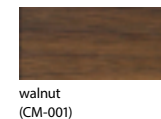

walnut (CM-001)



dark stained walnut (CM-002)

The Oris has a strong and commanding presence with its highly architectonic form. The thick solid stock walnut and solid aluminum central fin give the Oris a feeling of permanence and integration into the surrounding architecture. The simple asymmetrical composition adds an understated complexity, as well as excellent illumination, to any wall.

Nick Sheridan  
Designer

Emergency backup option available upon request, requires oversized J-box.

**Oris**  
sconce

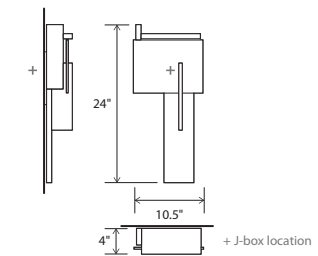

Dimensions: 24" x 10.5" x 4"  
 Materials: solid wood, polymer, aluminum  
 Product weight: 6 lbs  
 Light source: integrated LED  
 Light output: 1130 Lumens (source)  
 Light color: 2700 K or 3500 K  
 Color accuracy: 90+ CRI  
 LED power consumption: 13W  
 Dimmable (see driver below)  
 ADA compliant hotel room signage with tactile numbering and corresponding braille available  
 Wood grain will vary  
 Specifications subject to change



MATERIAL & FINISH OPTIONS

Oris part # 03-140-

<b>Metal Finish</b>	A	
brushed aluminum (CM-006)		
<b>Wood Body</b>	W	
walnut (CM-001)	D	
dark stained walnut (CM-002)		
<b>Lamping</b>		
2700 K LED	27	
3500 K LED	35	
<b>Driver</b>		
120-277 V AC input voltage	P1	
0-10V dimming		
TRIAC and ELV dimming at 120 V AC only		
<b>Includes</b>		
frosted polymer (CM-024)		

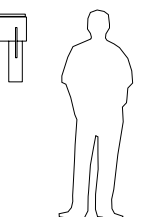







**Tersus**  
sconce

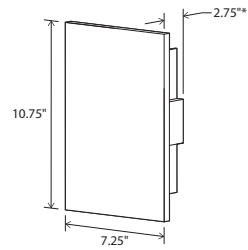

Dimensions: 10.75" x 7.25" x 2.75" (\*3.13" marble)  
 Materials: solid wood, polymer, metal option, stone option  
 Product weight: 2 lb (5 lb marble)  
 Light source: integrated LED  
 Light output: 1130 Lumens (source)  
 Light color: 2700 K or 3500 K  
 Color accuracy: 90+ CRI  
 Power usage: 13 W  
 Dimmable (see driver below)  
 Wood grain and stone will vary  
 Specifications subject to change



**MATERIAL & FINISH OPTIONS**

Tersus part # 03-136-

<b>Wood Body</b>	W
walnut (CM-001)	W
dark stained walnut (CM-002)	D
maple (CM-005)	M
<b>Optional Face Material</b>	
brushed aluminum (CM-012)	A
brushed rose gold (CM-046)	G
brushed brass (CM-047)	R
carrara marble (CM-078)	C
none (leave blank)	
<b>Lamping</b>	
2700 K LED	27
3500 K LED	35
<b>Driver</b>	
120-277 V AC input voltage	P1
0-10V dimming	
TRIAC and ELV dimming at 120 V AC only	
<b>Includes</b>	
frosted polymer (CM-024)	

J-box centered behind fixture

**WOOD BODY AND OPTIONAL FACE MATERIALS**

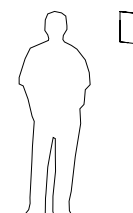
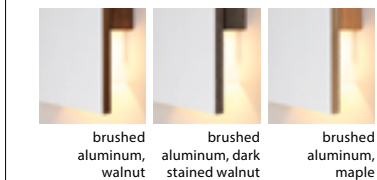
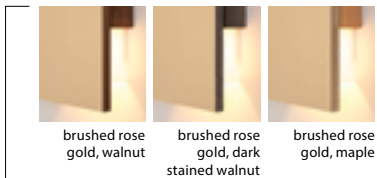

The Tersus is an example of the simplest form unlocking a myriad of design possibilities. The long reaching light pattern cast on the wall coupled with the numerous finishes and materials offered makes the Tersus well versed for all kinds of compositions and applications.

Nick Sheridan  
Designer

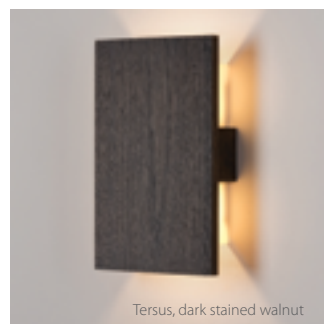
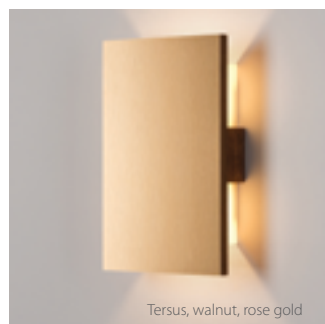
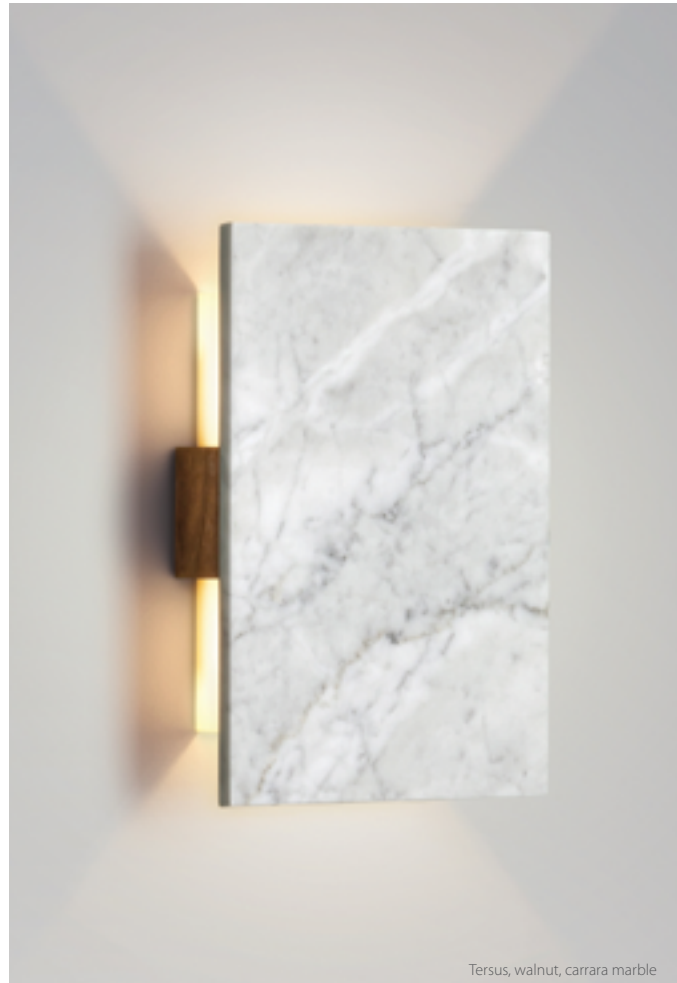

**Sedo**  
sconce

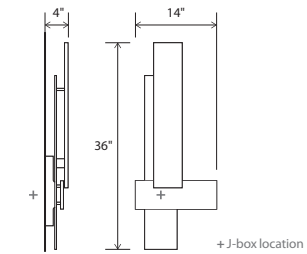

Dimensions: 36" x 14" x 4"  
 Materials: solid wood, polymer  
 Product weight: 6 lbs  
 Light source: integrated LED  
 Light output: 1130 Lumens (source)  
 Light color: 2700 K or 3500 K  
 Color accuracy: 90+ CRI  
 Power usage: 13 W  
 Dimmable (see driver below)  
 ADA compliant hotel room signage with tactile numbering and corresponding braille available  
 Wood grain will vary  
 Specifications subject to change



**MATERIAL & FINISH OPTIONS**

Sedo part # 03-133-

<b>Wood Body</b>	W
walnut (CM-001)	W
dark stained walnut (CM-002)	D
<b>Lamping</b>	
2700 K LED	27
3500 K LED	35
<b>Driver</b>	
120-277 V AC input voltage	P1
0-10 V dimming	
TRIAC and ELV dimming at 120 V AC only	
<b>Includes</b>	
frosted polymer (CM-024)	



The Sedo is composed of just three floating planes all kept parallel to the wall. This simple composition cloaks the light engine from view and filters the light as it is delivered far up and down the wall. It's this wall grazing and diffuser glow that gives the Sedo a strong architectural presence.

Nick Sheridan  
Designer

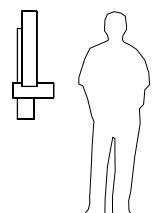

Emergency backup option available upon request, requires oversized J-box.





Ansa, distressed brass



The Ansa is a simple form that has been detailed and executed without compromise. The robust metal collar broadly trains the light while the light diffusing blades closely attenuate the wash pattern on the wall, yielding a simple and sophisticated feel.

Nick Sheridan  
Designer

**Ansa**  
sconce

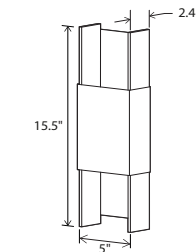

Dimensions: 15.5" x 5" x 2.4"  
Materials: metal, polymer  
Product weight: 3 lbs  
Light source: integrated LED  
Light output: 1130 Lumens (source)  
Light color: 2700 K or 3500 K  
Color accuracy: 90+ CRI  
Power usage: 13 W  
Dimmable (see driver below)  
Specifications subject to change



MATERIAL & FINISH OPTIONS

Ansa part # 03-137 -	
<i>Body</i>	
brushed aluminum (CM-006)	A
brushed brass (CM-008)	R
distressed brass (CM-009)	D
oiled bronze (CM-010)	Z
<i>Lamping</i>	
2700 K LED	27
3500 K LED	35
120-277 V AC input voltage	
0-10V dimming	
TRIAC and ELV dimming at 120 V AC only	P1



brushed aluminum (CM-006)



brushed brass (CM-008)

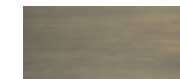

distressed brass (CM-009)

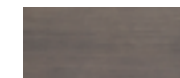

oiled bronze (CM-010)

*Includes*  
frosted polymer (CM-024)  
J-box centered behind fixture

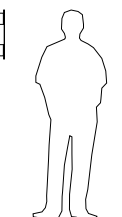



in collaboration with  
**DESIRON FRANK CARFARO**  
HAND CRAFTED AMERICAN FURNITURE

**Fortis**  
sconce

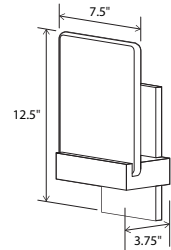

Dimensions: 12.5" x 7.5" x 3.75"  
Materials: solid wood, metal, artisan glass option, marble option  
Product weight: 10 lb  
Light source: integrated LED  
Light output: 565 Lumens (source)  
Light color: 2700 K or 3500 K  
Color accuracy: 90+ CRI  
Power usage: 7 W  
Dimmable (see driver below)  
Wood grain, bubbles in glass, and stone will vary  
Specifications subject to change



MATERIAL & FINISH OPTIONS

Fortis part # 03-170-

Metal Finish

- brushed brass (CM-008) R
- distressed brass (CM-009) D
- oiled bronze (CM-010) Z
- brushed aluminum (CM-006) A

Wood Finish

- walnut (CM-001) W
- dark stained walnut (CM-002) D

Diffuser

- artisan bubble glass (CM-059) B
- carrara marble (CM-078) C

Lamping

- 2700 K LED 27
- 3500 K LED 35

Driver

- 120 V AC input voltage TRIAC & ELV dimming P1
- 277 V AC input voltage 0-10V dimming P2

J-box centered behind metal plate



brushed brass (CM-008)

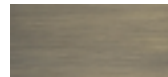

distressed brass (CM-009)



oiled bronze (CM-010)



brushed aluminum (CM-006)

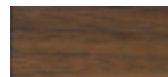

walnut (CM-001)



dark stained walnut (CM-002)

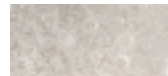

artisan bubble glass (CM-059)



carrara marble (CM-078)

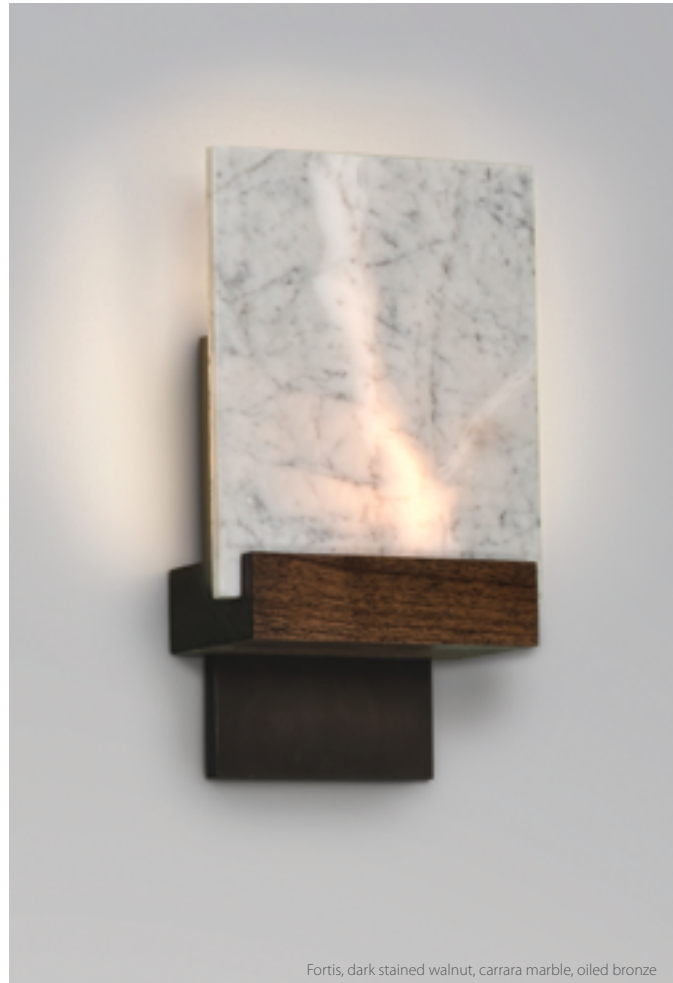

Fortis, dark stained walnut, carrara marble, oiled bronze



dark stained walnut, artisan glass, brushed brass



dark stained walnut, artisan glass, oiled bronze

The Fortis wall sconce is a great example of the collaborative design process. The initial concept from the New York based Desiron was refined over many iterations. We then worked with the local Southern California artisan glass company Siemon & Salazar to achieve a very specific bubbled glass lens that diffuses the light. It is a strong and sophisticated display of three elements: a piece of metal, a piece of wood, and a piece of glass all beautifully showcased in light.

Nick Sheridan  
Co-Designer

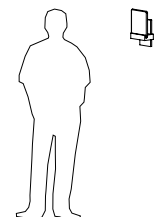

Clauco, walnut

The Clauco sconce showcases the beautiful natural walnut wood grain and sets it against the rigorous slits cut in each face as they wrap around the simple, clean shade form. A beautiful glow emanates from each slit, showing the striking rectilinear composition, in which all three sides are unique.

Nick Sheridan  
Designer

**Clauco**  
sconce

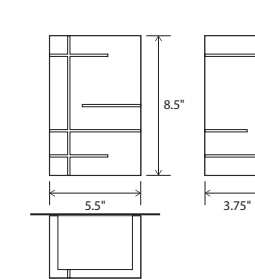

Dimensions: 8.5" x 5.5" x 3.75"  
Materials: solid wood, polymer  
Product weight: 4 lb  
Light source: integrated LED  
Light output: 1130 Lumens (source)  
Light color: 2700 K or 3500 K  
Color accuracy: 90+ CRI  
Power usage: 13 W  
Dimmable (see driver below)  
Wood grain will vary  
Specifications subject to change



MATERIAL & FINISH OPTIONS

Clauco sconce part # 03-150-

Wood Body

- walnut (CM-050) W
- dark stained walnut (CM-002) D

Lamping

- 2700 K LED 27
- 3500 K LED 35

- 120-277 V AC input voltage 0-10V dimming TRIAC and ELV dimming at 120 V AC only P1

Includes

- frosted polymer (CM-024)

J-box centered behind fixture

Also available in a pendant version, see page 41



walnut (CM-050)

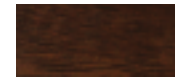

dark stained walnut (CM-002)

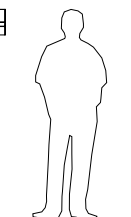



**Cubo**  
bedside wall sconce/reading lamp hybrid

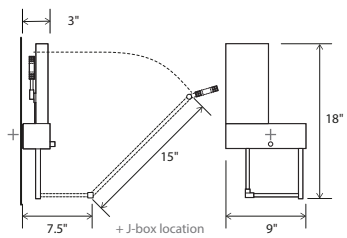

Dimensions: 18" x 9" x 3", 22.5" articulating arm  
 Materials: solid wood, aluminum, polymer  
 Product weight: 3 lb  
 Full arm and light head articulation  
 Light source: integrated LED  
 Light output: 345 Lumens (source)  
 Light color: 2700 K  
 Color accuracy: 90+ CRI  
 Power usage: 3.2 W  
 Dimmable on fixture  
 Input voltage: 12 V DC (adapter included)  
 Hardwired and corded versions available  
 Hardwired model includes an external power adapter (3" x 1.63" x 1.25")  
 Requires space in J-box for included power adapter  
 Wood grain will vary  
 Specifications subject to change



**OPTIONS**

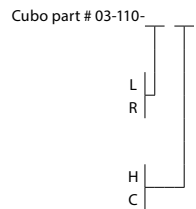

**Includes**  
 solid walnut body (CM-001)  
 aluminum arms (CM-006)  
 frosted polymer shade

Alternate voltage / plug styles available

\*Hardwired installation uses a standard 3" round plaster ring and requires room in the j box for the included external power supply. Get installation instructions at [www.cernogroup.com](http://www.cernogroup.com)

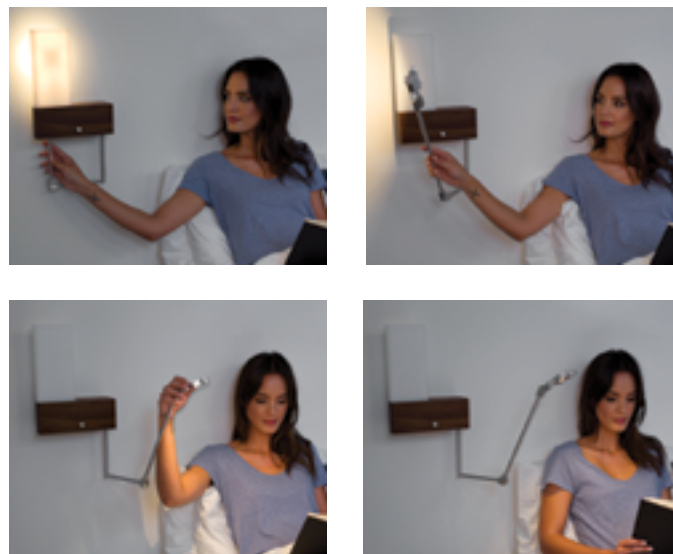
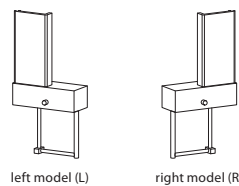

*Necessity is the mother of invention, and in this case illuminated activities in bed need highly controlled light — provided here without compromise, while still delivering a simple, clean wall sconce with ambient light — all in one fixture! — and it leaves your nightstand clutter free! Now that is modern.*

Nick Sheridan  
Designer

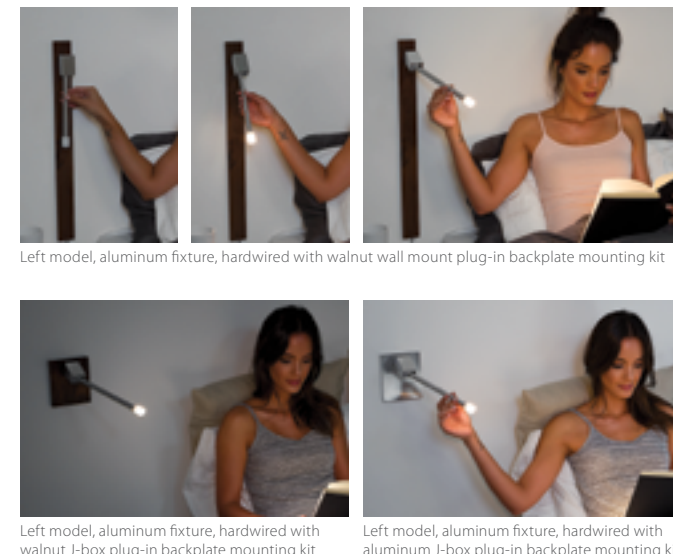

**Libri**  
bedside sconce reading light

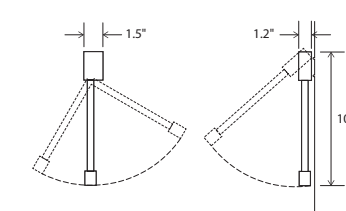

Dimensions: 10.5" x 1.5" x 1.2"  
 Materials: aluminum, polymer, optional solid wood mounting  
 Product weight: 1 lb  
 Light source: integrated LED  
 Light output: 160 Lumens (source)  
 Light color: 2700 K  
 Color accuracy: 90+ CRI  
 Power usage: 2 W  
 Automatic ON/OFF when arm is pulled away from wall  
 Specifications subject to change



**MATERIAL & FINISH OPTIONS**

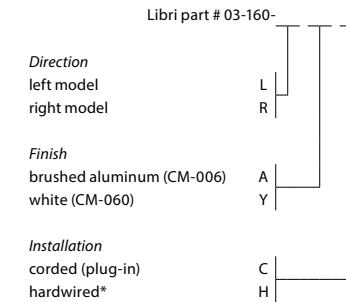

Alternate voltage / plug styles available  
 J-box centered behind fixture

**DIRECTION**

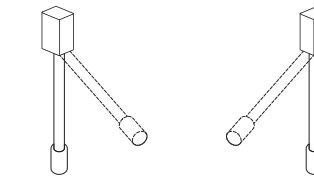

**INSTALLATION**

\*Hardwired installation requires room in the J-box for the included external power adapter (2" x 1" x 1.25"). Typically mounting kit is used. See mounting options on this page

**MOUNTING OPTIONS**  
 Mounting kits are sold separately from the Libri fixture.  
 No Mounting kit is required if the Libri fixture is to be installed using the Direct Mount option.

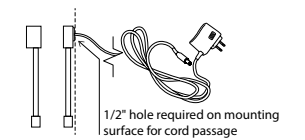

**Direct Mount**  
 Direct mount option is used when mounting directly to a headboard. There is no backplate and the cord must be fed through a hole in the headboard directly behind where the fixture is mounted and plugged into a wall outlet using the included AC adapter.

**Libri Mounting Kit**  
sconce backplate

**J-box Backplate: Mounting Kit (3)**  
 J-box backplate is typically used when mounting to a J-box. Hardwired installation requires room in the J-box for the included external power adapter (2" x 1" x 1.25").

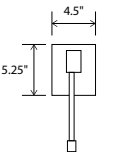

**Wall Mount Plug-in Backplate: Mounting Kit (1, 2)**  
 Wall mount plug-in backplate is used when mounting directly to the wall and plugging into a wall outlet. The wall mount is an elongated rectangle that allows the cord to exit discreetly below the fixture.

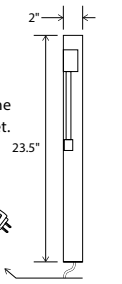

**MOUNTING KIT OPTIONS**

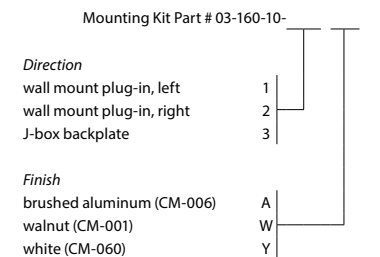

*The Libri is about function and ease: an extremely articulate directional task light in a discrete and sturdy form that is very intuitive to use.*

Nick Sheridan,  
Designer





Levo, walnut

REDDYMADE ARCHITECTURE AND DESIGN



Levo, right model

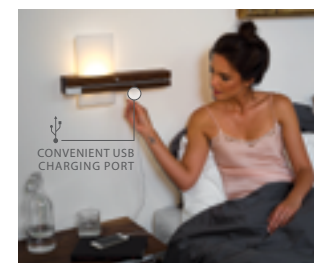
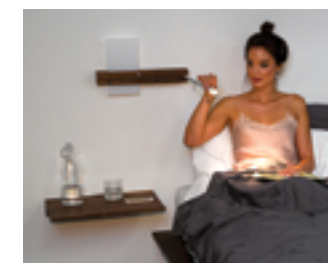

**Levo**  
bedside wall sconce/reading  
lamp hybrid with USB charger

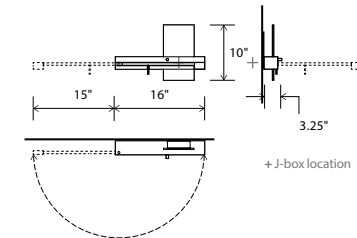

Dimensions: 10" x 16" x 3.25"  
Materials: solid wood, aluminum, polymer  
Product weight: 3 lb  
Light source: 2x integrated LED  
Static sconce light + swing arm with rotating head light  
Light output of static sconce source: 565 Lumens (source)  
Light output of swing arm source: 160 Lumens (source)  
Light color: 2700 K  
Color accuracy: 90+ CRI  
Power usage: 20 W total (10 W USB charger)  
USB charge current: 2 A  
Fully dimmable static sconce light with Automatic ON/OFF swing arm light source  
Swing arm light is not dimmable  
Input voltage: 12 V DC (adapter included)  
Hardwired and corded versions available  
Hardwired model includes an external power supply (2.75" x 1.63" x 1.13")  
Requires space in J-box for included power adapter  
Alternate voltage/plug styles available  
Hardwired adapter input voltage: 120-277 V AC  
Corded adapter input voltage: 120 V AC  
Wood grain will vary  
Specifications subject to change



**MATERIAL & FINISH OPTIONS**

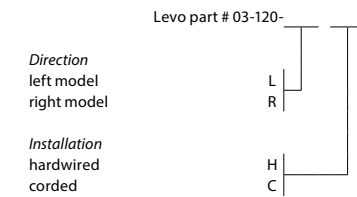

**Includes**  
solid walnut body (CM-001)  
brushed aluminum (CM-006)  
frosted polymer (CM-024)

Alternate voltage / plug styles available

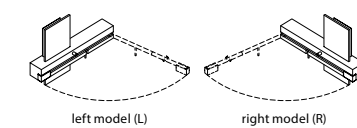

**Levo Shelf Option**



Levo, right model with shelf option

The introduction of the optional shelf for the Levo increases the utility of this fixture without compromising any aspect of the design. The shelf provides a perfect place to rest your phone or tablet while charging it. It is important to note that shelf is purchased separately from the Levo and can be retrofitted on existing Levos.

**MATERIAL & FINISH OPTIONS**

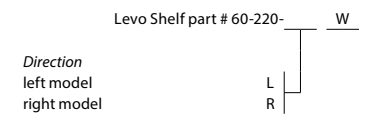

**Includes**  
solid walnut shelf (CM-001)  
brushed aluminum (CM-006)

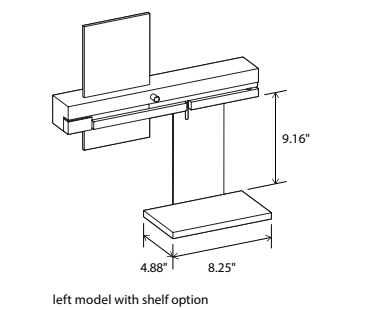

left model with shelf option

*The goal for the Levo was to create a bedside wall fixture with great task lighting articulation that was intuitive enough to be used without prior knowledge of the fixture: all the while making it slender, sexy, and very robust.*

Nick Sheridan,  
Designer





## Table



Forma



Nauta



Silva



Macto



in collaboration with  
**DESIRON FRANK CARFARO**  
HAND CRAFTED AMERICAN FURNITURE

**Forma Table**  
desk/table

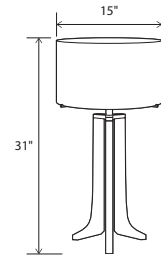

Dimensions: 15" Ø shade, 31"  
Materials: solid wood, aluminum, fabric shade  
Product weight: 10 lb  
Light source: medium base E26 socket  
Lamping: E26 base, type A lamp, 60 W max  
Input voltage: 120 V AC max  
Dimmable on fixture  
Wood grain will vary  
Specifications subject to change

Included dimmable LED A19 bulb  
Light output: 800 Lumens (source)  
Light color: 2700 K  
Color accuracy: 90+ CRI  
Power usage: 11 W

MATERIAL & FINISH OPTIONS

Forma Table part # 02-150-

Metal Finish

brushed aluminum (CM-006) A  
black anodized aluminum (CM-007) B

Wood Body

walnut (CM-001) W  
dark stained walnut (CM-002) D

Shade

black amaretto (CM-018) A  
white linen (CM-016) L  
burlap (CM-017) N

Alternate voltage / plug styles available  
Also available as a Floor Lamp, See page 16



Forma Table, walnut, black anodized aluminum, white linen



Being our most traditional fixture, Frank Carfaro and I worked to design a piece that embraced both Cerno and Desiron's aesthetic, without deviating too much from either brand's design language. I am really pleased with the fluidity, posture and scale we achieved with the Forma table, and its likeness to the Forma floor lamp.

Nick Sheridan  
Co-Designer

**Nauta Table**  
desk/table

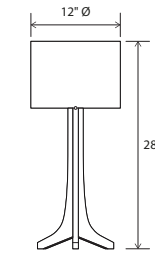

Dimensions: 12" Ø, 28"  
Materials: solid wood, aluminum, fabric shade  
Product weight: 3 lb  
Light source: medium base E26 socket  
Lamping: E26 base, 60 W max  
Input voltage: 250 V AC max  
Includes 8' clear silver cord with white plug  
On/Off rocker switch on socket  
Wood grain will vary  
Specifications subject to change

Included dimmable LED A19 bulb  
Light output: 800 Lumens (source)  
Light color: 2700 K  
Color accuracy: 90+ CRI  
Power usage: 11 W

MATERIAL & FINISH OPTIONS

Nauta Table part # 02-160-

Metal Finish

brushed aluminum (CM-006) A  
brushed brass (CM-008)\* R

Wood Body

walnut (CM-001) W  
dark stained walnut (CM-002) D

Shade

black amaretto (CM-018) A  
white linen (CM-016) L  
burlap (CM-017) N

\*Brass shade support arms feature wood plug in end of arm

in collaboration with  
**DESIRON FRANK CARFARO**  
HAND CRAFTED AMERICAN FURNITURE



walnut, brushed brass, burlap

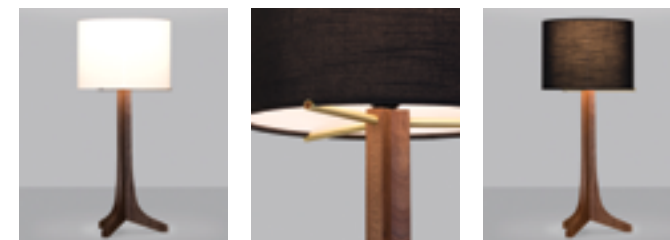

Efficiency and simplicity guided the design process for the Nauta table lamp. We designed the Forma several years ago with Frank Carfaro of Desiron, which profoundly influenced the Nauta's form. Our goal was to distill the Forma design without compromising it. The Nauta is clean, modern, and priced competitively.

Nick Sheridan  
Designer

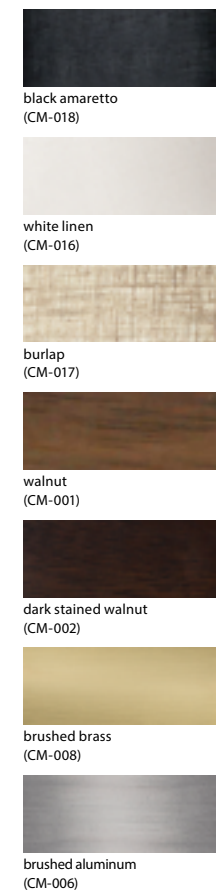



**Silva**  
desk/table

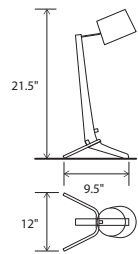

Dimensions: 12" x 9.5", 21.5"  
 Materials: solid wood, aluminum, bent shade  
 Articulating head  
 Product weight: 2 lb  
 Light source: integrated LED  
 Light output: 565 Lumens (source)  
 Light color: 2700 K  
 Color accuracy: 90+ CRI  
 Power usage: 7 W  
 Input voltage: 12V DC (adapter included)  
 White braided cord  
 Dimmable on fixture  
 Wood grain will vary  
 Specifications subject to change



**MATERIAL & FINISH OPTIONS**

Silva part # 02-100- A

<b>Metal Finish</b>	A
brushed aluminum (CM-006)	
<b>Wood Body</b>	W
walnut (CM-001)	
dark stained walnut (CM-002)	D
<b>Bent Shade</b>	B
beech wood veneer (CM-019)	
ebony eco veneer (CM-020)	E
white linen (CM-058)	L

Alternate voltage / plug styles available  
 Also available in two larger versions

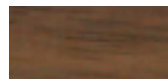

walnut (CM-001)



dark stained walnut (CM-002)



beech wood veneer (CM-019)



ebony eco veneer (CM-020)



white linen (CM-058)



Silva Table, walnut, white linen



dark stained walnut, ebony eco veneer

walnut, white linen

dark stained walnut, beech wood veneer

The structural connection between metal and wood was the inspiration here, where the fixture's stance is only strengthened by gravity. The tri-leg base finds stability on uneven surfaces and allows the cord to exit discreetly and effectively. It feels signature and iconic while still keeping a clean and timeless modern aesthetic.

Nick Sheridan  
 Designer

**Macto**  
desk/task

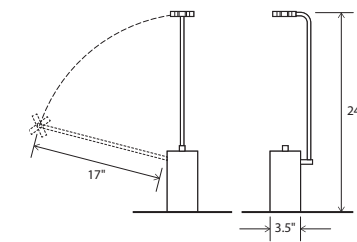

Dimensions: 3.5" x 3.5", 17" arm reach  
 Materials: solid wood, aluminum arm  
 Product weight: 5 lb  
 Light source: integrated LED  
 Light output: 345 Lumens (source)  
 Light color: 2700 K  
 Color accuracy: 90+ CRI  
 Power usage: 3.2 W  
 Input voltage: 12V DC (adapter included)  
 Black braided cord  
 Dimmable on fixture  
 Wood grain will vary  
 Specifications subject to change



walnut (CM-001)



dark stained walnut (CM-002)

**MATERIAL & FINISH OPTIONS**

Macto part # 02-140- A

<b>Metal Finish</b>	A
brushed aluminum (CM-006)	
<b>Wood Body</b>	W
walnut (CM-001)	
dark stained walnut (CM-002)	D

Alternate voltage / plug styles available



Macto, walnut

The Macto showcases the breathtaking natural beauty of the solid walnut base. Only in a truly solid piece of wood can you see the fascinating way that the grain changes as it passes from face to face. Great reach and articulation make the Macto an extremely functional and versatile fixture: while its form and composition are kept remarkably simple.

Nick Sheridan  
 Designer





Artist: Roy Nachum

STACI RUIZ LIGHTING CONSULTANT PHOTO BY ARI BURLING



Guy Rose, Impressionist

**Revelite AL**  
art light

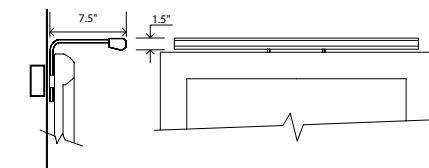

The Revelite AL brings art to life. A challenge resolved by a slim luminaire that discreetly and evenly illuminates an artwork surface with beautiful color rendering accuracy.

**CUSTOMIZED**

Each AL is custom built and factory calibrated for an artwork's specific dimensions, distributing even illumination across the full width and height of the surface.

**HIGH COLOR ACCURACY**

To accurately reflect the artist's vision, the LED light source was designed to provide full color spectrum lighting with a color rendering index over 90 and an R9 value of 83.

**ART SAFE**

Revelite AL's LED technology provides a much safer alternative to legacy sources that emit excessive and damaging UV and heat.

**LOW PROFILE**

The minimal form virtually disappears against the frame or wall and pairs well with various styles of art, including contemporary, photographs behind glass and more traditional works.

**VISIT**

[www.revelite.com](http://www.revelite.com) for detailed specifications and options.

US Patent # 7,070,293 and 9,134,004.

Other US and International Patents Pending.

*These lights revealed subtleties in paintings you just don't see with ordinary lights. I think we are seeing, truly for the first time, what the artist really wanted us to see.*

Pat Trenton, Ph.D.

Art expert, curator and writer

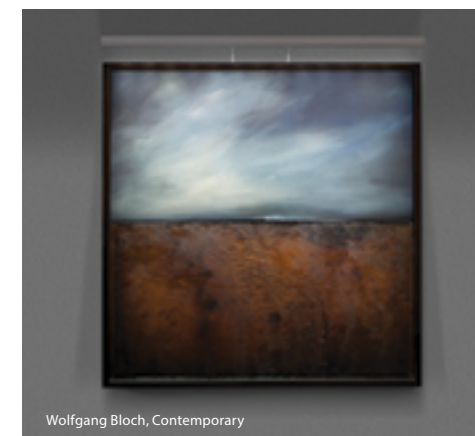

Wolfgang Bloch, Contemporary

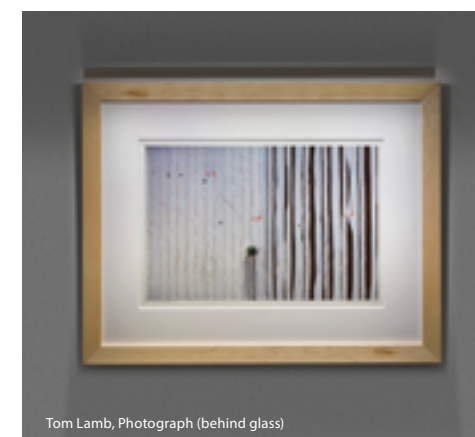

Tom Lamb, Photograph (behind glass)



Accessories



Motus Swing Arm Bracket  
accessory

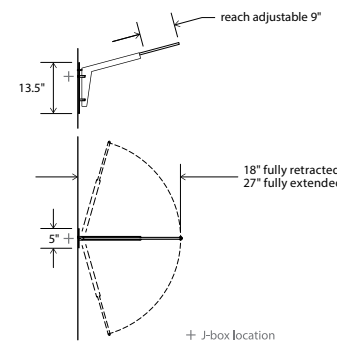

Dimensions: 18.38" x 5" x 26.8"  
Materials: solid wood, metal  
Product weight: 3 lb  
Max suspension weight: 5 lb  
Swing arm length can be adjusted from 18" to 27"  
Max drop length from tip of extended arm to top of pendant is 36"  
Swing arm rotation has adjustable resistance in pivot hinge  
Wood grain will vary  
Specifications subject to change  
Patent Pending



MATERIAL & FINISH OPTIONS

Motus Swing Arm Bracket part # 60-210-

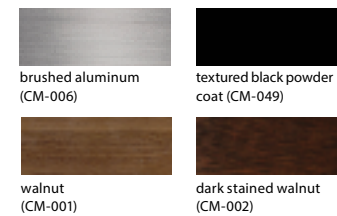

**Metal Finish**  
brushed aluminum (CM-006)  
textured black powdercoat (CM-049)

**Wood Body**  
walnut (CM-001)  
dark stained walnut (CM-002)

Please see the Talea on page 51

How it works: Build your own fixture

Pick one of the pendants listed below and pair it with the Motus Swing Arm Bracket for a unique and versatile light fixture. To order, you will need to select a SKU for the pendant that you choose and a SKU for the Motus Swing Arm Bracket. The SKU builder for the Motus Swing Arm Bracket is above, and the SKU builders for the pendants are located on their respective tear sheets.



Canopy Accessories



Multi-Point Round Canopy  
For 3 accent pendants

Dimensions: 12"Ø, 1.25" H

MATERIAL & FINISH OPTIONS

12" Round Canopy part # 60-120-R

**Finish**  
brushed aluminum (CM-006)  
black anodized (CM-007)

Multi-Point Linear Canopy  
For linear pendants or 2 or 3 accent pendants

Dimensions: 20.6" x 4", 1.3" H

MATERIAL & FINISH OPTIONS

Multi-Point Linear Canopy part # 60-130-

**Finish**  
brushed aluminum (CM-006)  
black anodized (CM-007)

**Number of Holes**  
2 Holes (linear pendant) leave blank  
3 Holes (pendant cluster)

Wood Canopy Cover

Fits over linear canopies except for Camur canopy (Camur wood canopy is on page 23)

Dimensions: 21" x 4.6", 1.75" H

MATERIAL & FINISH OPTIONS

Wood Canopy Cover part # 60-130-005

**Finish**  
walnut (CM-001)  
dark stained walnut (CM-002)

**Number of Holes**  
2 Holes (linear pendant) leave blank  
3 Holes (pendant cluster)

Hard Surface Shade



Brushed Aluminum (CM-006)  
Brushed Aluminum



Beech Wood Veneer (CM-019)  
Beech Wood Veneer

Fabric Shade



White Linen (CM-016)  
White Linen w/ Lamp Shade Backer



White Linen (CM-058)  
White Linen w/ Frosted Backer



Burlap (CM-017)  
Burlap w/ Lamp Shade Backer



Black Amaretto (CM-018)  
Black Amaretto Fabric w/ Lamp Shade Backer

Metal

Brushed Aluminum (CM-006)  
Brushed Aluminum

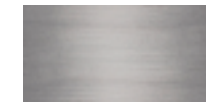

Brushed Aluminum (CM-012)  
Brushed Anodized Aluminum Veneer

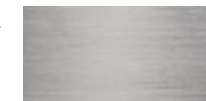

Black Anodized Aluminum (CM-007)  
Black Anodized Aluminum



Brushed Rose Gold (CM-046)  
Brushed Rose Gold Anodized Aluminum Veneer



Brushed Brass (CM-047)  
Brushed Brass Anodized Aluminum Veneer



Distressed Brass (CM-009)  
Distressed Brass - Patina

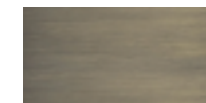

Brushed Brass (CM-008)  
Brushed Brass



Oiled Bronze (CM-010)  
Oiled Bronze - Patina

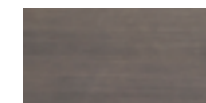

Textured Black Powdercoat (CM-049)  
Textured Black Powdercoat



Textured White Powdercoat (CM-060)  
Textured White Powdercoat

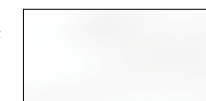

Gloss White (CM-054)  
White Powdercoat Aluminum Sheet



Wood



Walnut (CM-001)  
Solid Oiled Walnut



Walnut (CM-055)  
Oiled Walnut Veneer

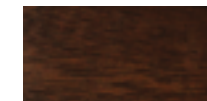

Dark Stained Walnut (CM-002)  
Solid Dark Stained Oiled Walnut

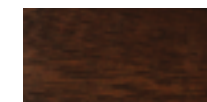

Dark Stained Walnut (CM-056)  
Dark Stained Oiled Walnut Veneer

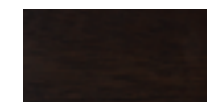

Double Dark Stained Walnut (CM-048)  
Solid Lacquered Double Dark Stained Walnut



Maple (CM-005)  
Solid Oiled Maple



White Washed Oak (CM-095)  
Solid White Washed Oak

Polymer

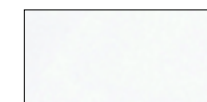

Frosted Polymer (CM-051)  
Frosted White Polycarbonate

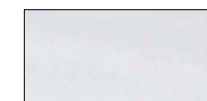

Frosted Polymer (CM-057)  
Frosted Polycarbonate

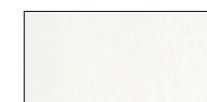

Frosted Polymer (CM-024)  
Frosted Acrylic

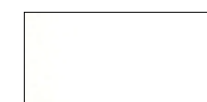

Polymer (CM-052)  
Natural Polyethylene

Stone

Carrara marble (CM-078)  
carrara marble

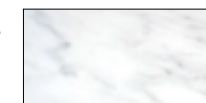

Artisan Bubble Glass

artisan bubble glass (CM-059)



⚠️WARNING. California Proposition 65 Warning for California Consumers. This product can expose you to chemicals including wood dust and lead which are known to the State of California to cause cancer or birth defects or other reproductive harm. For more information go to [www.P65Warnings.ca.gov](http://www.P65Warnings.ca.gov)



cerno®

D E S I G N E D   A N D   M A D E   I N   C A L I F O R N I A



cerno®  
DESIGNED AND MADE IN CALIFORNIA

CERNO, 1751 MCGAW AVE, IRVINE, CA 92614 | 949.715.1534 | WWW.CERNOGROUP.COM